

ENGINEERED POWER SOLUTIONS

72 SOUTH MAIN STREET, SUITE A
TEMPLETON, CA 93465

STRUCTURAL DOCUMENTATION PACKET

PROJECT:

Solar Warehouse Rail Analysis
Generic Packet for Flush Roof Mounted PV Rails

CLIENT:

Solar Warehouse
9628 Valley Blvd.
Rosemead, CA 91770

PREPARED BY:

Matthew B. Gilliss, P.E., LEED AP
Engineered Power Solutions, Inc.



Colorado Firm #20161321496

**This Packet Expires on 12/31/22 and is
Subject to Annual Renewal and Reissuance**

DATE: 2/16/22

EPS PROJECT NUMBER: 21-SWH001

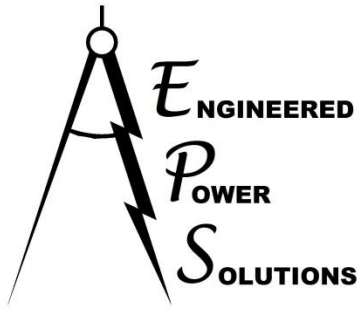

T.2 – Table of Contents

T.0 – PROJECT GENERAL INFORMATION

T.1 – Title Page

T.2 – Table of Contents

1.0 – RESULTS & SCOPE OF WORK

1.1 – Overview of Analysis & Results

1.2 – Scope of Work, Results, and Limitations

2.0 – DESIGN RESULTS AND SUMMARY TABLES

2.1 – Design Scenarios (Parameters)

2.2 – Rail Span Summary Tables

2.3 – Allowable Splice Locations

2.4 – Roof Zones

3.0 – SWH RAIL CALCULATIONS

3.1 – Roof Zone Determination

3.2 – Dead Loads

3.3 – Wind Forces

3.4 – Ground Snow Load Capacity

3.5 – Rail Load Summary

3.6 – Rail Analysis

3.7 – Rail Splice

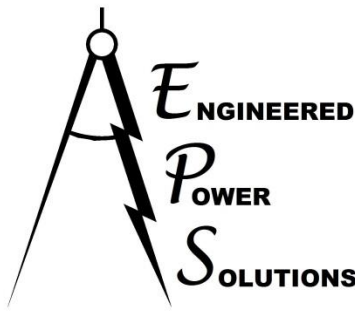

1.0 – RESULTS & SCOPE OF WORK

1.1 – Overview of Analysis & Results

- **Governing Building Code:**

2018 *International Building Code* (IBC)

Referencing the 2016 *Minimum Design Loads for Buildings and Other Structures* by the American Society of Civil Engineers (ASCE 7-16) including all supplements and errata.

- **Project Description:**

The project consists of the determination of the max span for the proposed rails to be used as a flush roof mounting system for Photovoltaic (PV) modules. The solar designer, Solar Warehouse (SWH) has contracted Engineered Power Solutions (EPS) to address the structural aspects of the rail, mainly the rail span of the proposed rail concepts. SWH has specified a number of common design scenarios that EPS has used to determine the maximum allowable rail spans for the (2) rail profiles proposed (Standard and Ecolite). These scenarios include design wind speed, wind exposure category, design ground snow load, orientation of module, tilt (pitch) of the roof/modules, roof zones, etc. SWH has also specified a number of design assumptions that remain constant for all scenarios which are discussed in further detail on the following pages.

Design and specification of the anchorage methods and fasteners that shall support the rail spans listed in this packet is by others since the anchor type is dependent on the existing building roofing and/or framing. It is also the responsibility of others to ensure any other hardware other than the rails (module clamps, components that anchor the rails to the existing structure, etc.) is structurally adequate for the imposed module, rail, and anchorage loads. This packet address the rail spans only.

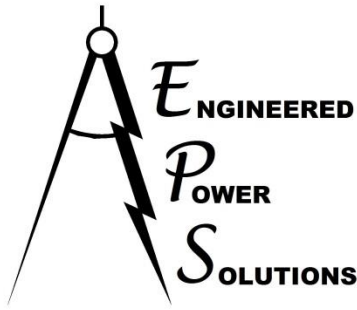

1.2 – Scope of Work, Results, and Limitations

- **Scope of Work:**

EPS has been hired by Solar Warehouse (SWH) to address the following items:

- Determination of the specified design loads on the flush mounted rail system including dead loads, wind loads, snow loads, seismic loads, etc. based on the parameters provided by SWH.
- Determination of the maximum allowable rail spans for the (2) proposed rail profiles (Standard and Ecolite) based on multiple loading scenarios, the section properties of the rails and racking components, and the geometry of the array.
- Allowable locations of the proposed rail splice in regards to rail span conditions.

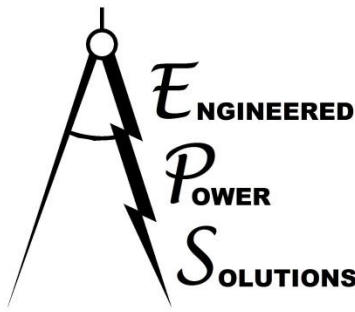

- **Results:**

The results of this analysis are presented on the following pages in the form of rail span summary tables based on the design scenarios provided by SWH. The final results are specified as maximum span of the rail under each specific scenario. Also included are diagrams showing the acceptable locations of the SHW rail splice based on the rail span conditions.

- **Limitations and Assumptions:**

This Structural Documentation Packet is not in reference of any specific project and only addresses the allowable spans of the proposed rail concept as a product for the generic design assumptions shown in this packet. It is recommended that these charts be used as an estimation tool only and a site specific analysis be performed by a licensed engineer for each project. Sites with design scenarios which differ and/or are outside the scenarios specified in this packet must be addressed by a licensed design professional on a site specific basis. Any changes to the required design results in the following tables must be approved by EPS prior to implementation.

EPS has not checked and is not responsible for the structural adequacy of the existing structure, nor is EPS responsible for the existing structure's ability to support the design loads imposed by the proposed PV system. This includes changes to the distribution of wind/snow design loads caused by the PV addition. It is also possible that a shorter rail span than those approved by the charts in this packet is required due to limitations of the building's structural framing, components, and cladding (roofing). It is the solar designer's and/or owner's responsibility to ensure that the structural aspects of the existing structure(s) affected by this new rooftop PV installation are addressed by a licensed engineer on a site specific basis and as required by the governing jurisdiction.

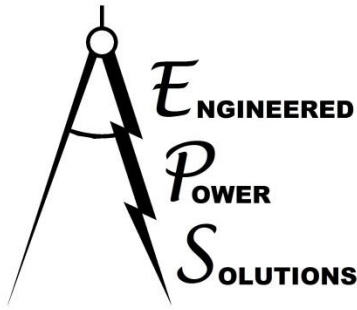

ENGINEERED POWER SOLUTIONS

72 SOUTH MAIN STREET, SUITE A
TEMPLETON, CA 93465

Specification of the anchorage methods, hardware, and fasteners that shall support the rails listed in this packet is by others since the anchor type is dependent on the existing building roofing and/or framing. It is also the responsibility of others to ensure the module clamps and any other components are structurally adequate for the imposed anchorage loads based on the fasteners used. This packet only address the maximum allowable rail spans and allowable splice locations.

All non-structural issues including but not limited to waterproofing, corrosion protection, electrical, ponding/drainage, roofing, and mechanical issues are not the responsibility of EPS and must be addressed by the solar designer, installer, and/or owner before PV installation begins.

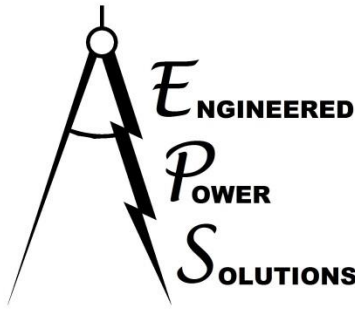

2.0 – DESIGN RESULTS AND SUMMARY TABLES

2.1 – Design Scenarios (Parameters)⁹

- **Building Code and Methodology:**
 - 2018 IBC and ASCE 7-16
 - [Also compatible with the 2012/2015 IBC and ASCE 7-10]
- **Varying Design Parameters:**
 - Module Orientation
 - Portrait (vertical)
 - Landscape (horizontal)
 - Wind Exposure Category^{2,4}:
 - Exposure “B”
 - Exposure “C”
 - Roof Mean Height⁵
 - ≤ 30 ft.
 - Design Wind Speed² (3 Second Gust Speed in MPH):
 - 100, 110, 115, 120, 130, 140, 150, 160, 170, 180, 200 (ASCE 7-16)
 - Roof Zone^{10, 11} (location of modules on roof):
 - Zone 1 (Interior Zone)
 - Zone 2 (Edge Zone)
 - Zone 3 (Corner Zone)
 - Ground Snow Load² (p_g) in psf
 - 0, 10, 20, 30, 40, 50, 60, 70, 80, 90, 100

→ see design parameter notes on following pages

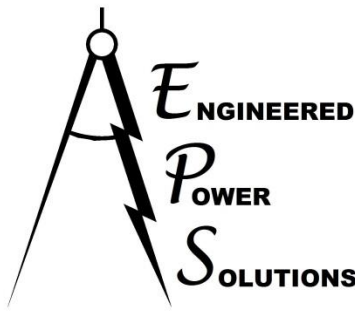

- **Constant Design Parameters:**
 - Size and Weight of Module¹:
 - 72-cell modules:
 - 78" x 40" / 55 lbs.
 - Wind Design Parameters:
 - Topographic Factor^{2,3} (K_{zt}): 1.00
 - Wind Directionality Factor² (K_d): 0.85
 - Velocity Pressure Exposure Coefficient^{2,4,5} (K_z):
 - Exposure B: $K_z = 0.7$
 - Exposure C: $K_z = 0.98$
 - Ground Elevation Factor¹² (K_e): 1.00
 - Snow Design Parameters:
 - Exposure Factor⁶ (C_e): 1.0
 - Thermal Factor (C_t): 1.2
 - Importance factor⁷ (I): 1.00
- **Assumptions:**
 - Max Spans listed in the summary tables are based on the assumption that the rails have a single span with the rail cantilevering beyond the last anchor on each side per Rail End Cantilever requirements listed below. Rail span increases for continuous rails over (3) spans or more are listed in the summary table notes.
 - Rail End Cantilever shall be:
 - No less than 25% of the rail span adjacent to the cantilever.
 - No more than 40% of the rail span adjacent to the cantilever.
 - Spans between 2 ft. – 9 ft. (0.5 ft. increments)
 - Module Tilt: Flush with roof (Roof tilt is limited to between 0° & 45°)¹¹
 - The existing structure the PV is being installed on is a Risk Category II (or less) structure. ⁷
 - Roof type shall be single Gable or Hip roof types only.¹¹

→ see design parameter notes on following pages

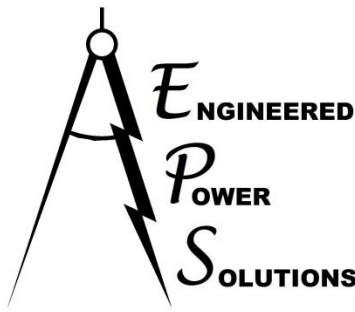

Design Parameter Notes:

- 1) Modules of different sizes and/or weights than those specified are not included in this analysis and shall be checked individually by a registered professional engineer. Results shown will be conservative for most 60 cell modules with areas smaller than the 72 cell module listed in this packet.
- 2) It is the solar designer/installer or owner's responsibility to determine the site specific design parameters of each site based on the current governing building code and/or local jurisdiction's requirements.
- 3) The site is assumed to have no topographic effects, i.e. it is not on a bluff, cliff, mesa, escarpment, upper half of a hill, or any other condition as described in the governing building code that would require a Topographic Factor other than 1.00.
- 4) Wind Exposure Categories considered are "B" and "C" as defined in ASCE 7. Wind Exposure Category "D" (sites overlooking bodies of water, mudflats, salt flats, and/or ice) has not been considered in this analysis. A site specific analysis is required for Wind Exposure "D" sites. It is the designer/installer, a 3rd party engineer, governing jurisdiction, or owner's responsibility to determine the wind exposure category of the site.
- 5) The building height listed is defined as the distance between the highest point of the PV system and grade. If the building has varying grade elevations, the lowest grade elevation shall be used. Projects where the height is greater than 30 ft. require a site specific analysis.
- 6) It is assumed the roof is "Partially Exposed" as described in ASCE 7. This assumption is conservative for buildings with "Fully Exposed" roofs. For buildings with "Sheltered" roofs, a site specific analysis is required.
- 7) The existing structure is considered to be Risk Category II structure (or less). Therefore, the snow importance factor (I_s) is 1.00 per Table 1.5-2 in ASCE 7. Buildings considered to be a Risk Category III and IV structure shall have the rail lengths be evaluated by a registered professional engineer on a site specific basis.
- 8) It is assumed that the rail is a single span conditions with the rail cantilevering on each side by at least 25% of the adjacent span but no more than 40% of the adjacent span.

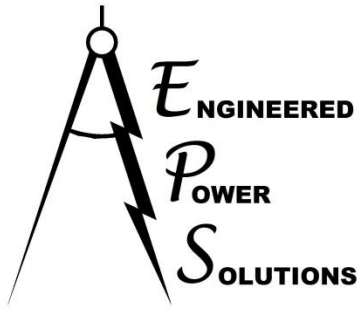

ENGINEERED POWER SOLUTIONS

72 SOUTH MAIN STREET, SUITE A
TEMPLETON, CA 93465

- 9) Any design parameter or scenario that is outside those listed in this packet requires a site-specific analysis. This packet is only to be used by a design professional with sufficient knowledge of the governing building code definitions and design parameters listed in this packet so that an accurate determination of the final project specific requirements can be made.
- 10) Roof interior (zone 1), edge (zone 2), and corner zones (zone 3) are considered for this analysis. Determination of the zone size and locations are provided in Section 2.4 of this packet.
- 11) See section 2.4 of this packet for further information on Roof Zones. Roof shall be single Gable/Hip type roof only. Stepped, Monoslope, Sawtooth, Domed, and Multispan Gable Roofs are not included and require a site-specific analysis.
- 12) Ground Elevation Factor is conservatively assumed to be 1.00 for all conditions per note 1 of Table 26.9-1 in ASCE 7-16.

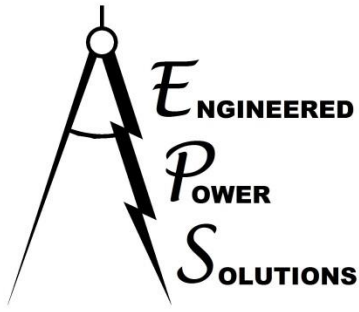

ENGINEERED POWER SOLUTIONS

72 SOUTH MAIN STREET, SUITE A
TEMPLETON, CA 93465

2.2 – Rail Span Summary Tables

Slope 0° -7°

Max Spans (ft)												
Zone 1'	Wind Speed (mph)	Ground Snow Load (psf)										
Exposure		0	10	20	30	40	50	60	70	80	90	100
Exp B	100	9.0	9.0	9.0	9.0	8.5	7.5	7.0	6.5	6.0	6.0	5.5
	110	9.0	9.0	9.0	9.0	8.5	7.5	7.0	6.5	6.0	6.0	5.5
	115	9.0	9.0	9.0	9.0	8.5	7.5	7.0	6.5	6.0	6.0	5.5
	120	9.0	9.0	9.0	9.0	8.5	7.5	7.0	6.5	6.0	6.0	5.5
	130	9.0	9.0	9.0	9.0	8.5	7.5	7.0	6.5	6.0	6.0	5.5
	140	9.0	9.0	9.0	9.0	8.5	7.5	7.0	6.5	6.0	6.0	5.5
	150	9.0	9.0	9.0	9.0	8.5	7.5	7.0	6.5	6.0	6.0	5.5
	160	9.0	9.0	9.0	9.0	8.5	7.5	7.0	6.5	6.0	6.0	5.5
	170	9.0	9.0	9.0	9.0	8.5	7.5	7.0	6.5	6.0	6.0	5.5
	180	8.5	8.5	8.5	8.5	8.5	7.5	7.0	6.5	6.0	6.0	5.5
200	8.0	8.0	8.0	8.0	8.0	7.5	7.0	6.5	6.0	6.0	5.5	

Max Spans (ft)												
Zone 1'	Wind Speed (mph)	Ground Snow Load (psf)										
Exposure		0	10	20	30	40	50	60	70	80	90	100
Exp C	100	9.0	9.0	9.0	9.0	8.5	7.5	7.0	6.5	6.0	6.0	5.5
	110	9.0	9.0	9.0	9.0	8.5	7.5	7.0	6.5	6.0	6.0	5.5
	115	9.0	9.0	9.0	9.0	8.5	7.5	7.0	6.5	6.0	6.0	5.5
	120	9.0	9.0	9.0	9.0	8.5	7.5	7.0	6.5	6.0	6.0	5.5
	130	9.0	9.0	9.0	9.0	8.5	7.5	7.0	6.5	6.0	6.0	5.5
	140	9.0	9.0	9.0	9.0	8.5	7.5	7.0	6.5	6.0	6.0	5.5
	150	9.0	9.0	9.0	9.0	8.5	7.5	7.0	6.5	6.0	6.0	5.5
	160	8.5	8.5	8.5	8.5	8.5	7.5	7.0	6.5	6.0	6.0	5.5
	170	8.0	8.0	8.0	8.0	8.0	7.5	7.0	6.5	6.0	6.0	5.5
	180	7.5	7.5	7.5	7.5	7.5	7.5	7.0	6.5	6.0	6.0	5.5
200	6.5	6.5	6.5	6.5	6.5	6.5	6.5	6.5	6.0	6.0	5.5	

NOTE: For rails that are continuous over less than 5 modules, reduce the listed max rail span by 1 ft.

Slope 0° -7°

Max Spans (ft)												
Zone 1 & 2	Wind Speed (mph)	Ground Snow Load (psf)										
Exposure		0	10	20	30	40	50	60	70	80	90	100
Exp B	100	9.0	9.0	9.0	9.0	8.5	7.5	7.0	6.5	6.0	6.0	5.5
	110	9.0	9.0	9.0	9.0	8.5	7.5	7.0	6.5	6.0	6.0	5.5
	115	9.0	9.0	9.0	9.0	8.5	7.5	7.0	6.5	6.0	6.0	5.5
	120	9.0	9.0	9.0	9.0	8.5	7.5	7.0	6.5	6.0	6.0	5.5
	130	9.0	9.0	9.0	9.0	8.5	7.5	7.0	6.5	6.0	6.0	5.5
	140	8.5	8.5	8.5	8.5	8.5	7.5	7.0	6.5	6.0	6.0	5.5
	150	8.0	8.0	8.0	8.0	8.0	7.5	7.0	6.5	6.0	6.0	5.5
	160	7.5	7.5	7.5	7.5	7.5	7.5	7.0	6.5	6.0	6.0	5.5
	170	7.0	7.0	7.0	7.0	7.0	7.0	7.0	6.5	6.0	6.0	5.5
	180	6.5	6.5	6.5	6.5	6.5	6.5	6.5	6.5	6.5	6.0	6.0
200	6.0	6.0	6.0	6.0	6.0	6.0	6.0	6.0	6.0	6.0	6.0	5.5

Max Spans (ft)												
Zone 1 & 2	Wind Speed (mph)	Ground Snow Load (psf)										
Exposure		0	10	20	30	40	50	60	70	80	90	100
Exp C	100	9.0	9.0	9.0	9.0	8.5	7.5	7.0	6.5	6.0	6.0	5.5
	110	9.0	9.0	9.0	9.0	8.5	7.5	7.0	6.5	6.0	6.0	5.5
	115	9.0	9.0	9.0	9.0	8.5	7.5	7.0	6.5	6.0	6.0	5.5
	120	8.5	8.5	8.5	8.5	8.5	7.5	7.0	6.5	6.0	6.0	5.5
	130	8.0	8.0	8.0	8.0	8.0	7.5	7.0	6.5	6.0	6.0	5.5
	140	7.0	7.0	7.0	7.0	7.0	7.0	7.0	6.5	6.0	6.0	5.5
	150	6.5	6.5	6.5	6.5	6.5	6.5	6.5	6.5	6.0	6.0	5.5
	160	6.0	6.0	6.0	6.0	6.0	6.0	6.0	6.0	6.0	6.0	5.5
	170	6.0	6.0	6.0	6.0	6.0	6.0	6.0	6.0	6.0	6.0	5.5
	180	5.5	5.5	5.5	5.5	5.5	5.5	5.5	5.5	5.5	5.5	5.5
200	5.0	5.0	5.0	5.0	5.0	5.0	5.0	5.0	5.0	5.0	5.0	5.0

NOTE: For rails that are continuous over less than 5 modules, reduce the listed max rail span by 1 ft.

Slope 0° -7°

Max Spans (ft)												
Zone 3	Wind Speed (mph)	Ground Snow Load (psf)										
Exposure		0	10	20	30	40	50	60	70	80	90	100
Exp B	100	9.0	9.0	9.0	9.0	8.5	7.5	7.0	6.5	6.0	6.0	5.5
	110	9.0	9.0	9.0	9.0	8.5	7.5	7.0	6.5	6.0	6.0	5.5
	115	8.5	8.5	8.5	8.5	8.5	7.5	7.0	6.5	6.0	6.0	5.5
	120	8.0	8.0	8.0	8.0	8.0	7.5	7.0	6.5	6.0	6.0	5.5
	130	7.5	7.5	7.5	7.5	7.5	7.5	7.0	6.5	6.0	6.0	5.5
	140	7.0	7.0	7.0	7.0	7.0	7.0	7.0	6.5	6.0	6.0	5.5
	150	6.5	6.5	6.5	6.5	6.5	6.5	6.5	6.5	6.0	6.0	5.5
	160	6.0	6.0	6.0	6.0	6.0	6.0	6.0	6.0	6.0	6.0	5.5
	170	5.5	5.5	5.5	5.5	5.5	5.5	5.5	5.5	5.5	5.5	5.5
	180	5.5	5.5	5.5	5.5	5.5	5.5	5.5	5.5	5.5	5.5	5.5
	200	4.5	4.5	4.5	4.5	4.5	4.5	4.5	4.5	4.5	4.5	4.5

Max Spans (ft)												
Zone 3	Wind Speed (mph)	Ground Snow Load (psf)										
Exposure		0	10	20	30	40	50	60	70	80	90	100
Exp C	100	8.0	8.0	8.0	8.0	8.0	7.5	7.0	6.5	6.0	6.0	5.5
	110	7.5	7.5	7.5	7.5	7.5	7.5	7.0	6.5	6.0	6.0	5.5
	115	7.0	7.0	7.0	7.0	7.0	7.0	7.0	6.5	6.0	6.0	5.5
	120	7.0	7.0	7.0	7.0	7.0	7.0	7.0	6.5	6.0	6.0	5.5
	130	6.0	6.0	6.0	6.0	6.0	6.0	6.0	6.0	6.0	6.0	5.5
	140	5.5	5.5	5.5	5.5	5.5	5.5	5.5	5.5	5.5	5.5	5.5
	150	5.5	5.5	5.5	5.5	5.5	5.5	5.5	5.5	5.5	5.5	5.5
	160	5.0	5.0	5.0	5.0	5.0	5.0	5.0	5.0	5.0	5.0	5.0
	170	4.5	4.5	4.5	4.5	4.5	4.5	4.5	4.5	4.5	4.5	4.5
	180	4.0	4.0	4.0	4.0	4.0	4.0	4.0	4.0	4.0	4.0	4.0
	200	3.5	3.5	3.5	3.5	3.5	3.5	3.5	3.5	3.5	3.5	3.5

NOTE: For rails that are continuous over less than 5 modules, reduce the listed max rail span by 1 ft.

Slope 7° - 20°

Max Spans (ft)												
Zone 1	Wind Speed (mph)	Ground Snow Load (psf)										
Exposure		0	10	20	30	40	50	60	70	80	90	100
Exp B	100	9.0	9.0	9.0	9.0	8.5	7.5	7.0	6.5	6.0	6.0	5.5
	110	9.0	9.0	9.0	9.0	8.5	7.5	7.0	6.5	6.0	6.0	5.5
	115	9.0	9.0	9.0	9.0	8.5	7.5	7.0	6.5	6.0	6.0	5.5
	120	9.0	9.0	9.0	9.0	8.5	7.5	7.0	6.5	6.0	6.0	5.5
	130	9.0	9.0	9.0	9.0	8.5	7.5	7.0	6.5	6.0	6.0	5.5
	140	9.0	9.0	9.0	9.0	8.5	7.5	7.0	6.5	6.0	6.0	5.5
	150	9.0	9.0	9.0	9.0	8.5	7.5	7.0	6.5	6.0	6.0	5.5
	160	8.5	8.5	8.5	8.5	8.5	7.5	7.0	6.5	6.0	6.0	5.5
	170	8.0	8.0	8.0	8.0	8.0	7.5	7.0	6.5	6.0	6.0	5.5
	180	7.5	7.5	7.5	7.5	7.5	7.5	7.0	6.5	6.0	6.0	5.5
200	7.0	7.0	7.0	7.0	7.0	7.0	7.0	7.0	6.5	6.0	6.0	5.5

Max Spans (ft)												
Zone 1	Wind Speed (mph)	Ground Snow Load (psf)										
Exposure		0	10	20	30	40	50	60	70	80	90	100
Exp C	100	9.0	9.0	9.0	9.0	8.5	7.5	7.0	6.5	6.0	6.0	5.5
	110	9.0	9.0	9.0	9.0	8.5	7.5	7.0	6.5	6.0	6.0	5.5
	115	9.0	9.0	9.0	9.0	8.5	7.5	7.0	6.5	6.0	6.0	5.5
	120	9.0	9.0	9.0	9.0	8.5	7.5	7.0	6.5	6.0	6.0	5.5
	130	9.0	9.0	9.0	9.0	8.5	7.5	7.0	6.5	6.0	6.0	5.5
	140	9.0	9.0	9.0	9.0	8.5	7.5	7.0	6.5	6.0	6.0	5.5
	150	8.5	8.5	8.5	8.5	8.0	7.5	7.0	6.5	6.0	6.0	5.5
	160	8.0	8.0	8.0	8.0	8.0	7.5	7.0	6.5	6.0	6.0	5.5
	170	7.5	7.5	7.5	7.5	7.5	7.5	7.0	6.5	6.0	6.0	5.5
	180	7.0	7.0	7.0	7.0	7.0	7.0	6.5	6.5	6.0	6.0	5.5
200	6.5	6.5	6.5	6.5	6.5	6.5	6.5	6.5	6.5	6.0	6.0	5.5

NOTE: For rails that are continuous over less than 5 modules, reduce the listed max rail span by 1 ft.

Slope 7° - 20°

Max Spans (ft)												
Zone 2*	Wind Speed (mph)	Ground Snow Load (psf)										
Exposure		0	10	20	30	40	50	60	70	80	90	100
Exp B	100	9.0	9.0	9.0	9.0	8.5	7.5	7.0	6.5	6.0	6.0	5.5
	110	9.0	9.0	9.0	9.0	8.5	7.5	7.0	6.5	6.0	6.0	5.5
	115	9.0	9.0	9.0	9.0	8.5	7.5	7.0	6.5	6.0	6.0	5.5
	120	9.0	9.0	9.0	9.0	8.5	7.5	7.0	6.5	6.0	6.0	5.5
	130	9.0	9.0	9.0	9.0	8.5	7.5	7.0	6.5	6.0	6.0	5.5
	140	8.5	8.5	8.5	8.5	8.0	7.0	6.5	6.5	6.0	6.0	5.5
	150	8.0	8.0	8.0	8.0	8.0	7.0	6.5	6.5	6.0	6.0	5.5
	160	7.5	7.5	7.5	7.5	7.5	6.5	6.5	6.0	6.0	6.0	5.5
	170	6.5	6.5	6.5	6.5	6.5	6.5	6.0	6.0	6.0	6.0	5.5
	180	6.5	6.5	6.5	6.5	6.5	6.5	6.0	6.0	6.0	6.0	5.5
200	5.5	5.5	5.5	5.5	5.5	5.5	5.5	5.5	5.5	5.5	5.5	

Max Spans (ft)												
Zone 2*	Wind Speed (mph)	Ground Snow Load (psf)										
Exposure		0	10	20	30	40	50	60	70	80	90	100
Exp C	100	9.0	9.0	9.0	9.0	8.5	7.5	7.0	6.5	6.0	6.0	5.5
	110	9.0	9.0	9.0	9.0	8.5	7.5	7.0	6.5	6.0	6.0	5.5
	115	8.5	8.5	8.5	8.5	8.0	7.5	7.0	6.5	6.0	6.0	5.5
	120	8.0	8.0	8.0	8.0	8.0	7.5	7.0	6.5	6.0	6.0	5.5
	130	7.5	7.5	7.5	7.5	7.5	7.0	7.0	6.5	6.0	6.0	5.5
	140	7.0	7.0	7.0	7.0	7.0	7.0	6.5	6.5	6.0	6.0	5.5
	150	6.5	6.5	6.5	6.5	6.5	6.5	6.0	6.0	6.0	6.0	5.5
	160	6.0	6.0	6.0	6.0	6.0	6.0	6.0	6.0	6.0	6.0	5.5
	170	5.5	5.5	5.5	5.5	5.5	5.5	5.5	5.5	5.5	5.5	5.5
	180	5.0	5.0	5.0	5.0	5.0	5.0	5.0	5.0	5.0	5.0	5.0
200	4.0	4.0	4.0	4.0	4.0	4.0	4.0	4.0	4.0	4.0	4.0	

*Zone 2 includes all zone designations (including 2e, 2n, 2r).

NOTE: For rails that are continuous over less than 5 modules, reduce the listed max rail span by 1 ft.

Slope 7° - 20°

Max Spans (ft)												
Zone 3**	Wind Speed (mph)	Ground Snow Load (psf)										
Exposure		0	10	20	30	40	50	60	70	80	90	100
Exp B	100	9.0	9.0	9.0	9.0	8.5	7.5	7.0	6.5	6.0	6.0	5.5
	110	9.0	9.0	9.0	9.0	8.5	7.5	7.0	6.5	6.0	6.0	5.5
	115	9.0	9.0	9.0	9.0	8.5	7.5	7.0	6.5	6.0	6.0	5.5
	120	8.5	8.5	8.5	8.5	8.0	7.5	7.0	6.5	6.0	6.0	5.5
	130	8.0	8.0	8.0	8.0	8.0	7.5	7.0	6.5	6.0	6.0	5.5
	140	7.0	7.0	7.0	7.0	7.0	7.0	7.0	6.5	6.0	6.0	5.5
	150	6.5	6.5	6.5	6.5	6.5	6.5	6.5	6.5	6.0	6.0	5.5
	160	6.0	6.0	6.0	6.0	6.0	6.0	6.0	6.0	6.0	6.0	5.5
	170	6.0	6.0	6.0	6.0	6.0	6.0	6.0	6.0	6.0	6.0	5.5
	180	5.5	5.5	5.5	5.5	5.5	5.5	5.5	5.5	5.5	5.5	5.5
200	4.5	4.5	4.5	4.5	4.5	4.5	4.5	4.5	4.5	4.5	4.5	

Max Spans (ft)												
Zone 3**	Wind Speed (mph)	Ground Snow Load (psf)										
Exposure		0	10	20	30	40	50	60	70	80	90	100
Exp C	100	8.5	8.5	8.5	8.5	8.5	7.5	7.0	6.5	6.0	6.0	5.5
	110	8.0	8.0	8.0	8.0	8.0	7.5	7.0	6.5	6.0	6.0	5.5
	115	7.5	7.5	7.5	7.5	7.5	7.0	7.0	6.5	6.0	6.0	5.5
	120	7.0	7.0	7.0	7.0	7.0	7.0	7.0	6.5	6.0	6.0	5.5
	130	6.5	6.5	6.5	6.5	6.5	6.5	6.5	6.5	6.0	6.0	5.5
	140	6.0	6.0	6.0	6.0	6.0	6.0	6.0	6.0	6.0	6.0	5.5
	150	5.5	5.5	5.5	5.5	5.5	5.5	5.5	5.5	5.5	5.5	5.5
	160	5.5	5.5	5.5	5.5	5.5	5.5	5.5	5.5	5.5	5.5	5.5
	170	5.0	5.0	5.0	5.0	5.0	5.0	5.0	5.0	5.0	5.0	5.0
	180	4.5	4.5	4.5	4.5	4.5	4.5	4.5	4.5	4.5	4.5	4.5
200	3.5	3.5	3.5	3.5	3.5	3.5	3.5	3.5	3.5	3.5	3.5	

**Zone 3 includes all zone designations (including 3, 3e & 3r).

NOTE: For rails that are continuous over less than 5 modules, reduce the listed max rail span by 1 ft.

Slope 20° - 27°

Max Spans (ft)												
Zone 1	Wind Speed (mph)	Ground Snow Load (psf)										
Exposure		0	10	20	30	40	50	60	70	80	90	100
Exp B	100	9.0	9.0	9.0	9.0	8.5	7.5	7.0	6.5	6.0	6.0	5.5
	110	9.0	9.0	9.0	9.0	8.5	7.5	7.0	6.5	6.0	6.0	5.5
	115	9.0	9.0	9.0	9.0	8.5	7.5	7.0	6.5	6.0	6.0	5.5
	120	9.0	9.0	9.0	9.0	8.5	7.5	7.0	6.5	6.0	6.0	5.5
	130	9.0	9.0	9.0	9.0	8.5	7.5	7.0	6.5	6.0	6.0	5.5
	140	9.0	9.0	9.0	9.0	8.5	7.5	7.0	6.5	6.0	6.0	5.5
	150	9.0	9.0	9.0	9.0	8.5	7.5	7.0	6.5	6.0	6.0	5.5
	160	8.5	8.5	8.5	8.5	8.0	7.5	7.0	6.5	6.0	6.0	5.5
	170	8.0	8.0	8.0	8.0	7.5	6.5	6.0	6.0	6.0	6.0	5.5
	180	7.0	7.0	7.0	7.0	6.0	5.5	5.5	5.5	5.5	5.0	5.0
200	6.0	6.0	6.0	6.0	6.0	5.5	5.5	5.0	5.0	5.0	5.0	

Max Spans (ft)												
Zone 1	Wind Speed (mph)	Ground Snow Load (psf)										
Exposure		0	10	20	30	40	50	60	70	80	90	100
Exp C	100	9.0	9.0	9.0	9.0	8.5	7.5	7.0	6.5	6.0	6.0	5.5
	110	9.0	9.0	9.0	9.0	8.5	7.5	7.0	6.5	6.0	6.0	5.5
	115	9.0	9.0	9.0	9.0	8.5	7.5	7.0	6.5	6.0	6.0	5.5
	120	9.0	9.0	9.0	9.0	8.5	7.5	7.0	6.5	6.0	6.0	5.5
	130	9.0	9.0	9.0	9.0	8.5	7.5	7.0	6.5	6.0	6.0	5.5
	140	9.0	9.0	9.0	9.0	8.5	7.5	7.0	6.5	6.0	5.5	5.5
	150	8.5	8.5	8.5	8.5	7.5	7.0	6.5	6.0	5.5	5.5	5.5
	160	8.0	8.0	8.0	7.5	7.0	6.5	6.0	5.5	5.5	5.5	5.0
	170	7.0	7.0	7.0	6.5	6.0	5.5	5.5	5.5	5.5	5.0	5.0
	180	6.5	6.5	6.5	6.5	5.5	5.5	5.5	5.5	5.5	5.0	5.0
200	5.5	5.5	5.5	5.5	5.5	5.5	5.5	5.0	5.0	5.0	5.0	

NOTE: For rails that are continuous over less than 5 modules, reduce the listed max rail span by 1 ft.

Slope 20° - 27°

Max Spans (ft)												
Zone 2*	Wind Speed (mph)	Ground Snow Load (psf)										
Exposure		0	10	20	30	40	50	60	70	80	90	100
Exp B	100	9.0	9.0	9.0	9.0	8.5	7.5	7.0	6.5	6.0	6.0	5.5
	110	9.0	9.0	9.0	9.0	8.5	7.5	7.0	6.5	6.0	6.0	5.5
	115	9.0	9.0	9.0	9.0	8.5	7.5	7.0	6.5	6.0	6.0	5.5
	120	9.0	9.0	9.0	9.0	8.5	7.5	7.0	6.5	6.0	6.0	5.5
	130	9.0	9.0	9.0	9.0	8.5	7.5	7.0	6.5	6.0	6.0	5.5
	140	9.0	9.0	9.0	9.0	8.5	7.5	7.0	6.5	6.0	6.0	5.5
	150	8.5	8.5	8.5	8.5	8.5	7.5	7.0	6.5	6.0	6.0	5.5
	160	8.0	8.0	8.0	8.0	8.0	7.5	7.0	6.5	6.0	6.0	5.5
	170	7.0	7.0	7.0	7.0	7.0	7.0	7.0	6.5	6.0	6.0	5.5
	180	7.0	7.0	7.0	7.0	7.0	7.0	7.0	6.5	6.0	6.0	5.5
200	6.0	6.0	6.0	6.0	6.0	6.0	6.0	6.0	6.0	6.0	5.5	

Max Spans (ft)												
Zone 2*	Wind Speed (mph)	Ground Snow Load (psf)										
Exposure		0	10	20	30	40	50	60	70	80	90	100
Exp C	100	9.0	9.0	9.0	9.0	8.5	7.5	7.0	6.5	6.0	6.0	5.5
	110	9.0	9.0	9.0	9.0	8.5	7.5	7.0	6.5	6.0	6.0	5.5
	115	9.0	9.0	9.0	9.0	8.5	7.5	7.0	6.5	6.0	6.0	5.5
	120	8.5	8.5	8.5	8.5	8.5	7.5	7.0	6.5	6.0	6.0	5.5
	130	8.0	8.0	8.0	8.0	8.0	7.5	7.0	6.5	6.0	6.0	5.5
	140	7.5	7.5	7.5	7.5	7.5	7.5	7.0	6.5	6.0	6.0	5.5
	150	7.0	7.0	7.0	7.0	7.0	7.0	7.0	6.5	6.0	6.0	5.5
	160	6.5	6.5	6.5	6.5	6.5	6.5	6.5	6.5	6.0	6.0	5.5
	170	6.0	6.0	6.0	6.0	6.0	6.0	6.0	6.0	6.0	6.0	5.5
	180	5.5	5.5	5.5	5.5	5.5	5.5	5.5	5.5	5.5	5.5	5.5
200	4.5	4.5	4.5	4.5	4.5	4.5	4.5	4.5	4.5	4.5	4.5	

*Zone 2 includes all zone designations (including 2e, 2n, 2r).

NOTE: For rails that are continuous over less than 5 modules, reduce the listed max rail span by 1 ft.

Slope 20° - 27°

Max Spans (ft)												
Zone 3**	Wind Speed (mph)	Ground Snow Load (psf)										
Exposure		0	10	20	30	40	50	60	70	80	90	100
Exp B	100	9.0	9.0	9.0	9.0	8.5	7.5	7.0	6.5	6.0	6.0	5.5
	110	9.0	9.0	9.0	9.0	8.5	7.5	7.0	6.5	6.0	6.0	5.5
	115	9.0	9.0	9.0	9.0	8.5	7.5	7.0	6.5	6.0	6.0	5.5
	120	9.0	9.0	9.0	9.0	8.5	7.5	7.0	6.5	6.0	6.0	5.5
	130	8.5	8.5	8.5	8.5	8.5	7.5	7.0	6.5	6.0	6.0	5.5
	140	7.5	7.5	7.5	7.5	7.5	7.5	7.0	6.5	6.0	6.0	5.5
	150	7.0	7.0	7.0	7.0	7.0	7.0	7.0	6.5	6.0	6.0	5.5
	160	6.5	6.5	6.5	6.5	6.5	6.5	6.5	6.5	6.0	6.0	5.5
	170	6.5	6.5	6.5	6.5	6.5	6.5	6.5	6.5	6.0	6.0	5.5
	180	6.0	6.0	6.0	6.0	6.0	6.0	6.0	6.0	6.0	6.0	5.5
200	5.0	5.0	5.0	5.0	5.0	5.0	5.0	5.0	5.0	5.0	5.0	

Max Spans (ft)												
Zone 3**	Wind Speed (mph)	Ground Snow Load (psf)										
Exposure		0	10	20	30	40	50	60	70	80	90	100
Exp C	100	9.0	9.0	9.0	9.0	8.5	7.5	7.0	6.5	6.0	6.0	5.5
	110	8.5	8.5	8.5	8.5	8.5	7.5	7.0	6.5	6.0	6.0	5.5
	115	8.0	8.0	8.0	8.0	8.0	7.5	7.0	6.5	6.0	6.0	5.5
	120	7.5	7.5	7.5	7.5	7.5	7.5	7.0	6.5	6.0	6.0	5.5
	130	7.0	7.0	7.0	7.0	7.0	7.0	7.0	6.5	6.0	6.0	5.5
	140	6.5	6.5	6.5	6.5	6.5	6.5	6.5	6.5	6.0	6.0	5.5
	150	6.0	6.0	6.0	6.0	6.0	6.0	6.0	6.0	6.0	6.0	5.5
	160	6.0	6.0	6.0	6.0	6.0	6.0	6.0	6.0	6.0	6.0	5.5
	170	5.5	5.5	5.5	5.5	5.5	5.5	5.5	5.5	5.5	5.5	5.5
	180	5.0	5.0	5.0	5.0	5.0	5.0	5.0	5.0	5.0	5.0	5.0
200	4.0	4.0	4.0	4.0	4.0	4.0	4.0	4.0	4.0	4.0	4.0	

**Zone 3 includes all zone designations (including 3, 3e & 3r).

NOTE: For rails that are continuous over less than 5 modules, reduce the listed max rail span by 1 ft.

Slope 27° - 45°

Max Spans (ft)												
Zone 1	Wind Speed (mph)	Ground Snow Load (psf)										
Exposure		0	10	20	30	40	50	60	70	80	90	100
Exp B	100	9.0	9.0	9.0	9.0	8.5	8.0	7.5	7.0	6.5	6.0	6.0
	110	9.0	9.0	9.0	9.0	8.5	8.0	7.5	7.0	6.5	6.0	6.0
	115	9.0	9.0	9.0	9.0	8.5	8.0	7.0	7.0	6.5	6.0	6.0
	120	9.0	9.0	9.0	9.0	8.5	7.5	7.0	7.0	6.5	6.0	6.0
	130	9.0	9.0	9.0	9.0	8.0	7.5	7.0	6.5	6.5	6.0	6.0
	140	9.0	9.0	9.0	8.5	8.0	7.5	7.0	6.5	6.0	6.0	6.0
	150	9.0	9.0	9.0	8.5	8.0	7.5	7.0	6.5	6.0	6.0	6.0
	160	9.0	9.0	9.0	8.5	7.5	7.0	6.5	6.5	6.0	6.0	5.5
	170	9.0	9.0	9.0	8.0	7.5	7.0	6.5	6.5	6.0	6.0	5.5
	180	8.5	8.5	8.0	8.0	7.5	7.0	6.5	6.0	6.0	6.0	5.5
200	7.5	7.5	7.5	7.5	7.0	7.0	6.5	6.0	6.0	6.0	5.5	

Max Spans (ft)												
Zone 1	Wind Speed (mph)	Ground Snow Load (psf)										
Exposure		0	10	20	30	40	50	60	70	80	90	100
Exp C	100	9.0	9.0	9.0	9.0	8.0	7.5	7.0	6.5	6.5	6.0	6.0
	110	9.0	9.0	9.0	9.0	8.0	7.5	7.0	6.5	6.5	6.0	6.0
	115	9.0	9.0	9.0	9.0	8.0	7.5	7.0	6.5	6.5	6.0	6.0
	120	9.0	9.0	9.0	8.5	8.0	7.5	7.0	6.5	6.0	6.0	6.0
	130	9.0	9.0	9.0	8.5	8.0	7.0	7.0	6.5	6.0	6.0	6.0
	140	9.0	9.0	9.0	8.0	7.5	7.0	6.5	6.5	6.0	6.0	5.5
	150	9.0	9.0	8.5	8.0	7.5	7.0	6.5	6.0	6.0	6.0	5.5
	160	8.5	8.5	8.0	7.5	7.0	6.5	6.5	6.0	6.0	5.5	5.5
	170	8.0	8.0	7.5	7.5	7.0	6.5	6.0	6.0	6.0	5.5	5.0
	180	7.5	7.5	7.0	7.0	6.5	6.5	6.0	6.0	5.5	5.5	5.0
200	6.5	6.5	6.5	6.5	6.0	6.0	6.0	6.0	5.5	5.5	5.0	

NOTE: For rails that are continuous over less than 5 modules, reduce the listed max rail span by 1 ft.

Slope 27° - 45°

Max Spans (ft)												
Zone 2*	Wind Speed (mph)	Ground Snow Load (psf)										
Exposure		0	10	20	30	40	50	60	70	80	90	100
Exp B	100	9.0	9.0	9.0	9.0	8.5	8.0	7.5	7.0	6.5	6.0	6.0
	110	9.0	9.0	9.0	9.0	8.5	8.0	7.5	7.0	6.5	6.0	6.0
	115	9.0	9.0	9.0	9.0	8.5	8.0	7.0	7.0	6.5	6.0	6.0
	120	9.0	9.0	9.0	9.0	8.5	7.5	7.0	7.0	6.5	6.0	6.0
	130	9.0	9.0	9.0	9.0	8.0	7.5	7.0	6.5	6.5	6.0	6.0
	140	9.0	9.0	9.0	8.5	8.0	7.5	7.0	6.5	6.0	6.0	6.0
	150	9.0	9.0	9.0	8.5	7.5	7.0	7.0	6.5	6.0	6.0	6.0
	160	8.5	8.5	8.5	8.0	7.0	6.5	6.5	6.5	6.0	6.0	5.5
	170	8.0	8.0	8.0	7.0	6.5	6.0	6.0	6.0	6.0	6.0	5.5
	180	7.5	7.5	7.5	7.0	6.5	6.0	6.0	6.0	6.0	6.0	5.5
	200	6.5	6.5	6.5	6.5	6.5	6.0	5.5	5.0	5.0	5.0	5.0

Max Spans (ft)												
Zone 2*	Wind Speed (mph)	Ground Snow Load (psf)										
Exposure		0	10	20	30	40	50	60	70	80	90	100
Exp C	100	9.0	9.0	9.0	9.0	8.0	7.5	7.0	6.5	6.5	6.0	6.0
	110	9.0	9.0	9.0	9.0	8.0	7.5	7.0	6.5	6.5	6.0	6.0
	115	9.0	9.0	9.0	9.0	8.0	7.5	7.0	6.5	6.5	6.0	6.0
	120	9.0	9.0	9.0	8.5	8.0	7.5	7.0	6.5	6.0	6.0	6.0
	130	9.0	9.0	9.0	8.0	7.5	7.0	7.0	6.5	6.0	6.0	6.0
	140	8.5	8.5	8.5	7.5	7.0	7.0	6.5	6.5	6.0	6.0	5.5
	150	8.0	8.0	7.5	7.0	7.0	7.0	6.5	6.0	6.0	6.0	5.5
	160	7.5	7.5	7.5	6.5	6.5	6.5	6.5	6.0	6.0	5.5	5.5
	170	7.0	7.0	7.0	6.5	6.0	6.0	6.0	5.5	5.5	5.5	5.0
	180	6.5	6.5	6.5	6.0	5.5	5.5	5.5	5.5	5.5	5.5	5.0
	200	5.5	5.5	5.5	5.5	5.5	5.5	5.0	5.0	5.0	5.0	5.0

*Zone 2 includes all zone designations (including 2e, 2n, 2r).

NOTE: For rails that are continuous over less than 5 modules, reduce the listed max rail span by 1 ft.

Slope 27° - 45°

Max Spans (ft)												
Zone 3**	Wind Speed (mph)	Ground Snow Load (psf)										
Exposure		0	10	20	30	40	50	60	70	80	90	100
Exp B	100	9.0	9.0	9.0	9.0	8.5	8.0	7.5	7.0	6.5	6.0	6.0
	110	9.0	9.0	9.0	9.0	8.5	8.0	7.5	7.0	6.5	6.0	6.0
	115	9.0	9.0	9.0	9.0	8.5	8.0	7.0	7.0	6.5	6.0	6.0
	120	9.0	9.0	9.0	9.0	8.5	7.5	7.0	7.0	6.5	6.0	6.0
	130	9.0	9.0	9.0	9.0	8.0	7.5	7.0	6.5	6.5	6.0	6.0
	140	9.0	9.0	9.0	8.5	8.0	7.5	7.0	6.5	6.0	6.0	6.0
	150	8.5	8.5	8.5	8.0	7.5	7.5	7.0	6.5	6.0	6.0	6.0
	160	8.0	8.0	8.0	7.5	7.0	6.5	6.5	6.5	6.0	6.0	5.5
	170	7.0	7.0	7.0	6.5	6.5	6.5	6.0	6.0	5.5	5.5	5.5
	180	6.5	6.5	6.5	6.0	5.5	5.0	5.0	5.0	5.0	5.0	5.0
200	5.5	5.5	5.5	5.5	5.5	5.0	4.5	4.5	4.5	4.5	4.5	

Max Spans (ft)												
Zone 3**	Wind Speed (mph)	Ground Snow Load (psf)										
Exposure		0	10	20	30	40	50	60	70	80	90	100
Exp C	100	9.0	9.0	9.0	9.0	8.0	7.5	7.0	6.5	6.5	6.0	6.0
	110	9.0	9.0	9.0	9.0	8.0	7.5	7.0	6.5	6.5	6.0	6.0
	115	9.0	9.0	9.0	8.5	8.0	7.5	7.0	6.5	6.5	6.0	6.0
	120	9.0	9.0	9.0	8.0	8.0	7.5	7.0	6.5	6.0	6.0	6.0
	130	8.5	8.5	8.5	7.5	7.5	7.0	7.0	6.5	6.0	6.0	6.0
	140	8.0	8.0	8.0	7.0	7.0	7.0	6.5	6.5	6.0	6.0	5.5
	150	7.0	7.0	7.0	6.5	6.5	6.5	6.5	6.0	6.0	6.0	5.5
	160	6.5	6.5	6.5	6.0	6.0	6.0	5.5	5.5	5.5	5.0	5.0
	170	6.0	6.0	6.0	5.5	5.5	5.5	5.0	5.0	5.0	4.5	4.5
	180	5.5	5.5	5.5	5.0	5.0	5.0	4.5	4.5	4.5	4.5	4.0
200	4.5	4.5	4.5	4.5	4.5	4.5	4.0	4.0	4.0	4.0	4.0	

**Zone 3 includes all zone designations (including 3, 3e & 3r).

NOTE: For rails that are continuous over less than 5 modules, reduce the listed max rail span by 1 ft.

Slope 0° -7°

Max Spans (ft)												
Zone 1'	Wind Speed (mph)	Ground Snow Load (psf)										
Exposure		0	10	20	30	40	50	60	70	80	90	100
Exp B	100	9.0	9.0	8.5	7.0	6.0	5.5	5.0	4.5	4.5	4.0	4.0
	110	9.0	9.0	8.5	7.0	6.0	5.5	5.0	4.5	4.5	4.0	4.0
	115	9.0	9.0	8.5	7.0	6.0	5.5	5.0	4.5	4.5	4.0	4.0
	120	9.0	9.0	8.5	7.0	6.0	5.5	5.0	4.5	4.5	4.0	4.0
	130	9.0	9.0	8.5	7.0	6.0	5.5	5.0	4.5	4.5	4.0	4.0
	140	9.0	9.0	8.5	7.0	6.0	5.5	5.0	4.5	4.5	4.0	4.0
	150	8.5	8.5	8.5	7.0	6.0	5.5	5.0	4.5	4.5	4.0	4.0
	160	7.5	7.5	7.5	7.0	6.0	5.5	5.0	4.5	4.5	4.0	4.0
	170	7.0	7.0	7.0	7.0	6.0	5.5	5.0	4.5	4.5	4.0	4.0
	180	7.0	7.0	7.0	7.0	6.0	5.5	5.0	4.5	4.5	4.0	4.0
200	5.5	5.5	5.5	5.5	5.5	5.5	5.5	5.0	4.5	4.5	4.0	4.0

Max Spans (ft)												
Zone 1'	Wind Speed (mph)	Ground Snow Load (psf)										
Exposure		0	10	20	30	40	50	60	70	80	90	100
Exp C	100	9.0	9.0	8.5	7.0	6.0	5.5	5.0	4.5	4.5	4.0	4.0
	110	9.0	9.0	8.5	7.0	6.0	5.5	5.0	4.5	4.5	4.0	4.0
	115	9.0	9.0	8.5	7.0	6.0	5.5	5.0	4.5	4.5	4.0	4.0
	120	8.5	8.5	8.5	7.0	6.0	5.5	5.0	4.5	4.5	4.0	4.0
	130	8.0	8.0	8.0	7.0	6.0	5.5	5.0	4.5	4.5	4.0	4.0
	140	7.5	7.5	7.5	7.0	6.0	5.5	5.0	4.5	4.5	4.0	4.0
	150	7.0	7.0	7.0	7.0	6.0	5.5	5.0	4.5	4.5	4.0	4.0
	160	6.5	6.5	6.5	6.5	6.0	5.5	5.0	4.5	4.5	4.0	4.0
	170	6.0	6.0	6.0	6.0	6.0	5.5	5.0	4.5	4.5	4.0	4.0
	180	6.0	6.0	6.0	6.0	6.0	5.5	5.0	4.5	4.5	4.0	4.0
200	4.5	4.5	4.5	4.5	4.5	4.5	4.5	4.5	4.5	4.5	4.0	4.0

NOTE: For rails that are continuous over less than 5 modules, reduce the listed max rail span by 1 ft.

Slope 0° -7°

Max Spans (ft)												
Zone 1 & 2	Wind Speed (mph)	Ground Snow Load (psf)										
Exposure		0	10	20	30	40	50	60	70	80	90	100
Exp B	100	8.0	8.0	8.0	7.0	6.5	5.5	5.0	4.5	4.5	4.0	4.0
	110	7.5	7.5	7.5	6.5	6.0	5.5	5.0	4.5	4.5	4.0	4.0
	115	7.0	7.0	7.0	6.5	6.0	5.5	5.0	4.5	4.5	4.0	4.0
	120	6.5	6.5	6.5	6.5	6.0	5.5	5.0	4.5	4.5	4.0	4.0
	130	6.0	6.0	6.0	6.0	5.5	5.5	5.0	4.5	4.5	4.0	4.0
	140	5.5	5.5	5.5	5.5	5.0	5.0	5.0	4.5	4.5	4.0	4.0
	150	5.0	5.0	5.0	5.0	5.0	5.0	5.0	4.5	4.5	4.0	4.0
	160	5.0	5.0	5.0	5.0	5.0	5.0	5.0	4.5	4.5	4.0	4.0
	170	4.5	4.5	4.5	4.5	4.5	4.5	4.5	4.5	4.5	4.0	4.0
	180	4.0	4.0	4.0	4.0	4.0	4.0	4.0	4.0	4.0	4.0	4.0
	200	3.0	3.0	3.0	3.0	3.0	3.0	3.0	3.0	3.0	3.0	3.0

Max Spans (ft)												
Zone 1 & 2	Wind Speed (mph)	Ground Snow Load (psf)										
Exposure		0	10	20	30	40	50	60	70	80	90	100
Exp C	100	7.0	7.0	7.0	6.5	6.0	5.5	5.0	4.5	4.5	4.0	4.0
	110	6.5	6.5	6.5	6.0	6.0	5.5	5.0	4.5	4.5	4.0	4.0
	115	6.0	6.0	6.0	6.0	5.5	5.5	5.0	4.5	4.5	4.0	4.0
	120	5.5	5.5	5.5	5.5	5.0	5.0	5.0	4.5	4.5	4.0	4.0
	130	5.0	5.0	5.0	5.0	5.0	5.0	5.0	4.5	4.5	4.0	4.0
	140	4.5	4.5	4.5	4.5	4.5	4.5	4.5	4.5	4.5	4.0	4.0
	150	4.0	4.0	4.0	4.0	4.0	4.0	4.0	4.0	4.0	4.0	4.0
	160	4.0	4.0	4.0	4.0	4.0	4.0	4.0	4.0	4.0	3.5	3.5
	170	3.5	3.5	3.5	3.5	3.5	3.5	3.5	3.5	3.5	3.0	3.0
	180	3.5	3.5	3.5	3.5	3.5	3.5	3.5	3.5	3.5	3.0	3.0
	200	2.0	2.0	2.0	2.0	2.0	2.0	2.0	2.0	2.0	2.0	2.0

NOTE: For rails that are continuous over less than 5 modules, reduce the listed max rail span by 1 ft.

Slope 0° -7°

Max Spans (ft)												
Zone 3	Wind Speed (mph)	Ground Snow Load (psf)										
Exposure		0	10	20	30	40	50	60	70	80	90	100
Exp B	100	7.5	7.5	7.5	7.0	6.0	5.5	5.0	4.5	4.5	4.0	4.0
	110	7.0	7.0	7.0	7.0	6.0	5.5	5.0	4.5	4.5	4.0	4.0
	115	6.5	6.5	6.5	6.5	6.0	5.5	5.0	4.5	4.5	4.0	4.0
	120	6.5	6.5	6.5	6.5	6.0	5.5	5.0	4.5	4.5	4.0	4.0
	130	6.0	6.0	6.0	6.0	6.0	5.5	5.0	4.5	4.5	4.0	4.0
	140	5.5	5.5	5.5	5.5	5.5	5.5	5.0	4.5	4.5	4.0	4.0
	150	5.0	5.0	5.0	5.0	5.0	5.0	5.0	4.5	4.5	4.0	4.0
	160	4.5	4.5	4.5	4.5	4.5	4.5	4.5	4.5	4.5	4.0	4.0
	170	4.5	4.5	4.5	4.5	4.5	4.5	4.5	4.5	4.5	4.0	4.0
	180	4.0	4.0	4.0	4.0	4.0	4.0	4.0	4.0	4.0	4.0	4.0
	200	3.0	3.0	3.0	3.0	3.0	3.0	3.0	3.0	3.0	3.0	3.0

Max Spans (ft)												
Zone 3	Wind Speed (mph)	Ground Snow Load (psf)										
Exposure		0	10	20	30	40	50	60	70	80	90	100
Exp C	100	6.5	6.5	6.5	6.5	6.0	5.5	5.0	4.5	4.5	4.0	4.0
	110	6.0	6.0	6.0	6.0	6.0	5.5	5.0	4.5	4.5	4.0	4.0
	115	6.0	6.0	6.0	6.0	6.0	5.5	5.0	4.5	4.5	4.0	4.0
	120	5.5	5.5	5.5	5.5	5.5	5.5	5.0	4.5	4.5	4.0	4.0
	130	5.0	5.0	5.0	5.0	5.0	5.0	5.0	4.5	4.5	4.0	4.0
	140	4.5	4.5	4.5	4.5	4.5	4.5	4.5	4.5	4.5	4.0	4.0
	150	4.0	4.0	4.0	4.0	4.0	4.0	4.0	4.0	4.0	4.0	4.0
	160	4.0	4.0	4.0	4.0	4.0	4.0	4.0	4.0	4.0	4.0	4.0
	170	3.5	3.5	3.5	3.5	3.5	3.5	3.5	3.5	3.5	3.5	3.5
	180	3.5	3.5	3.5	3.5	3.5	3.5	3.5	3.5	3.5	3.5	3.5
	200	2.0	2.0	2.0	2.0	2.0	2.0	2.0	2.0	2.0	2.0	2.0

NOTE: For rails that are continuous over less than 5 modules, reduce the listed max rail span by 1 ft.

Slope 7° - 20°

Max Spans (ft)												
Zone 1	Wind Speed (mph)	Ground Snow Load (psf)										
Exposure		0	10	20	30	40	50	60	70	80	90	100
Exp B	100	9.0	9.0	8.5	7.0	6.0	5.5	5.0	4.5	4.5	4.0	4.0
	110	9.0	9.0	8.5	7.0	6.0	5.5	5.0	4.5	4.5	4.0	4.0
	115	9.0	9.0	8.5	7.0	6.0	5.5	5.0	4.5	4.5	4.0	4.0
	120	8.5	8.5	8.0	7.0	6.0	5.5	5.0	4.5	4.5	4.0	4.0
	130	8.0	8.0	7.5	7.0	6.0	5.5	5.0	4.5	4.5	4.0	4.0
	140	7.0	7.0	6.5	6.5	6.0	5.5	5.0	4.5	4.5	4.0	4.0
	150	6.5	6.5	6.5	6.0	5.5	5.0	5.0	4.5	4.5	4.0	4.0
	160	6.0	6.0	6.0	6.0	5.5	5.5	5.0	4.5	4.5	4.0	4.0
	170	5.5	5.5	5.5	5.5	5.5	5.0	5.0	4.5	4.5	4.0	4.0
	180	5.0	5.0	5.0	5.0	4.5	4.5	4.5	4.0	4.0	4.0	4.0
200	4.0	4.0	4.0	4.0	4.0	3.5	3.5	3.5	3.5	3.5	3.5	

Max Spans (ft)												
Zone 1	Wind Speed (mph)	Ground Snow Load (psf)										
Exposure		0	10	20	30	40	50	60	70	80	90	100
Exp C	100	9.0	9.0	8.5	7.0	6.0	5.5	5.0	4.5	4.5	4.0	4.0
	110	8.5	8.5	8.0	7.0	6.0	5.5	5.0	4.5	4.5	4.0	4.0
	115	8.0	8.0	8.0	7.0	6.0	5.5	5.0	4.5	4.5	4.0	4.0
	120	7.5	7.5	7.5	7.0	6.0	5.5	5.0	4.5	4.5	4.0	4.0
	130	7.0	7.0	7.0	6.5	6.0	5.5	5.0	4.5	4.5	4.0	4.0
	140	6.5	6.5	6.5	6.5	5.5	5.5	5.0	4.5	4.5	4.0	4.0
	150	6.0	6.0	6.0	6.0	5.5	5.5	5.0	4.5	4.5	4.0	4.0
	160	5.5	5.5	5.5	5.5	5.5	5.0	5.0	4.5	4.5	4.0	4.0
	170	5.0	5.0	5.0	5.0	5.0	5.0	5.0	4.5	4.5	4.0	4.0
	180	4.5	4.5	4.5	4.5	4.5	4.5	4.5	4.5	4.5	4.0	4.0
200	3.0	3.0	3.0	3.0	3.0	3.0	3.0	3.0	3.0	3.0	3.0	

NOTE: For rails that are continuous over less than 5 modules, reduce the listed max rail span by 1 ft.

Slope 7° - 20°

Max Spans (ft)												
Zone 2*	Wind Speed (mph)	Ground Snow Load (psf)										
Exposure		0	10	20	30	40	50	60	70	80	90	100
Exp B	100	9.0	9.0	8.0	7.0	6.0	5.5	5.0	4.5	4.5	4.0	4.0
	110	8.5	8.5	8.0	7.0	6.0	5.5	5.0	4.5	4.5	4.0	4.0
	115	8.0	8.0	8.0	7.0	6.0	5.5	5.0	4.5	4.5	4.0	4.0
	120	7.5	7.5	7.5	7.0	6.0	5.5	5.0	4.5	4.5	4.0	4.0
	130	7.0	7.0	7.0	6.5	6.0	5.5	5.0	4.5	4.5	4.0	4.0
	140	6.5	6.5	6.5	6.5	6.0	5.5	5.0	4.5	4.5	4.0	4.0
	150	6.0	6.0	6.0	6.0	6.0	5.5	5.0	4.5	4.5	4.0	4.0
	160	5.5	5.5	5.5	5.5	5.5	5.5	5.0	4.5	4.5	4.0	4.0
	170	5.0	5.0	5.0	5.0	5.0	5.0	5.0	4.5	4.5	4.0	4.0
	180	4.5	4.5	4.5	4.5	4.5	4.5	4.5	4.5	4.5	4.0	4.0
	200	3.5	3.5	3.5	3.5	3.5	3.5	3.5	3.5	3.5	3.5	3.5

Max Spans (ft)												
Zone 2*	Wind Speed (mph)	Ground Snow Load (psf)										
Exposure		0	10	20	30	40	50	60	70	80	90	100
Exp C	100	7.5	7.5	7.5	7.0	6.0	5.5	5.0	4.5	4.5	4.0	4.0
	110	7.0	7.0	7.0	7.0	6.0	5.5	5.0	4.5	4.5	4.0	4.0
	115	6.5	6.5	6.5	6.5	6.0	5.5	5.0	4.5	4.5	4.0	4.0
	120	6.0	6.0	6.0	6.0	6.0	5.5	5.0	4.5	4.5	4.0	4.0
	130	5.5	5.5	5.5	5.5	5.5	5.5	5.0	4.5	4.5	4.0	4.0
	140	5.5	5.5	5.5	5.5	5.5	5.5	5.0	4.5	4.5	4.0	4.0
	150	5.0	5.0	5.0	5.0	5.0	5.0	5.0	4.5	4.5	4.0	4.0
	160	4.5	4.5	4.5	4.5	4.5	4.5	4.5	4.5	4.5	4.0	4.0
	170	4.0	4.0	4.0	4.0	4.0	4.0	4.0	4.0	4.0	4.0	4.0
	180	4.0	4.0	4.0	4.0	4.0	4.0	4.0	4.0	4.0	4.0	4.0
	200	2.5	2.5	2.5	2.5	2.5	2.5	2.5	2.5	2.5	2.5	2.5

*Zone 2 includes all zone designations (including 2e, 2n, 2r).

NOTE: For rails that are continuous over less than 5 modules, reduce the listed max rail span by 1 ft.

Slope 7° - 20°

Max Spans (ft)												
Zone 3**	Wind Speed (mph)	Ground Snow Load (psf)										
Exposure		0	10	20	30	40	50	60	70	80	90	100
Exp B	100	7.5	7.5	7.0	7.0	6.0	5.5	5.0	4.5	4.5	4.0	4.0
	110	7.0	7.0	7.0	7.0	6.0	5.5	5.0	4.5	4.5	4.0	4.0
	115	6.5	6.5	6.5	6.5	6.0	5.5	5.0	4.5	4.5	4.0	4.0
	120	6.5	6.5	6.5	6.5	6.0	5.5	5.0	4.5	4.5	4.0	4.0
	130	6.0	6.0	6.0	6.0	6.0	5.5	5.0	4.5	4.5	4.0	4.0
	140	5.5	5.5	5.5	5.5	5.5	5.5	5.0	4.5	4.5	4.0	4.0
	150	5.0	5.0	5.0	5.0	5.0	5.0	5.0	4.5	4.5	4.0	4.0
	160	4.5	4.5	4.5	4.5	4.5	4.5	4.5	4.5	4.5	4.0	4.0
	170	4.5	4.5	4.5	4.5	4.5	4.5	4.5	4.5	4.5	4.0	4.0
	180	4.0	4.0	4.0	4.0	4.0	4.0	4.0	4.0	4.0	4.0	4.0
200	3.0	3.0	3.0	3.0	3.0	3.0	3.0	3.0	3.0	3.0	3.0	

Max Spans (ft)												
Zone 3**	Wind Speed (mph)	Ground Snow Load (psf)										
Exposure		0	10	20	30	40	50	60	70	80	90	100
Exp C	100	6.5	6.5	6.5	6.0	6.0	5.5	5.0	4.5	4.5	4.0	4.0
	110	6.0	6.0	6.0	6.0	6.0	5.5	5.0	4.5	4.5	4.0	4.0
	115	6.0	6.0	6.0	6.0	6.0	5.5	5.0	4.5	4.5	4.0	4.0
	120	5.5	5.5	5.5	5.5	5.5	5.5	5.0	4.5	4.5	4.0	4.0
	130	5.0	5.0	5.0	5.0	5.0	5.0	5.0	4.5	4.5	4.0	4.0
	140	4.5	4.5	4.5	4.5	4.5	4.5	4.5	4.5	4.5	4.0	4.0
	150	4.0	4.0	4.0	4.0	4.0	4.0	4.0	4.0	4.0	4.0	4.0
	160	4.0	4.0	4.0	4.0	4.0	4.0	4.0	4.0	4.0	4.0	4.0
	170	3.5	3.5	3.5	3.5	3.5	3.5	3.5	3.5	3.5	3.5	3.5
	180	3.5	3.5	3.5	3.5	3.5	3.5	3.5	3.5	3.5	3.5	3.5
200	2.0	2.0	2.0	2.0	2.0	2.0	2.0	2.0	2.0	2.0	2.0	

**Zone 3 includes all zone designations (including 3, 3e & 3r).

NOTE: For rails that are continuous over less than 5 modules, reduce the listed max rail span by 1 ft.

Slope 20° - 27°

Max Spans (ft)												
Zone 1	Wind Speed (mph)	Ground Snow Load (psf)										
Exposure		0	10	20	30	40	50	60	70	80	90	100
Exp B	100	9.0	9.0	8.5	7.0	6.0	5.5	5.0	4.5	4.5	4.0	4.0
	110	9.0	9.0	8.5	7.0	6.0	5.5	5.0	4.5	4.5	4.0	4.0
	115	9.0	9.0	8.5	7.0	6.0	5.5	5.0	4.5	4.5	4.0	4.0
	120	8.5	8.5	8.0	7.0	6.0	5.5	5.0	4.5	4.5	4.0	4.0
	130	8.0	8.0	8.0	7.0	6.0	5.5	5.0	4.5	4.5	4.0	4.0
	140	7.5	7.5	7.5	7.0	6.0	5.5	5.0	4.5	4.5	4.0	4.0
	150	7.0	7.0	7.0	6.5	6.0	5.5	5.0	4.5	4.5	4.0	4.0
	160	6.5	6.5	6.5	6.5	6.0	5.5	5.0	4.5	4.5	4.0	4.0
	170	6.0	6.0	6.0	6.0	6.0	5.5	5.0	4.5	4.5	4.0	4.0
	180	5.5	5.5	5.5	5.5	5.5	5.5	5.5	5.0	4.5	4.5	4.0
200	4.5	4.5	4.5	4.5	4.5	4.5	4.5	4.5	4.5	4.5	4.0	4.0

Max Spans (ft)												
Zone 1	Wind Speed (mph)	Ground Snow Load (psf)										
Exposure		0	10	20	30	40	50	60	70	80	90	100
Exp C	100	9.0	9.0	8.0	7.0	6.0	5.5	5.0	4.5	4.5	4.0	4.0
	110	8.5	8.5	8.0	7.0	6.0	5.5	5.0	4.5	4.5	4.0	4.0
	115	8.0	8.0	8.0	7.0	6.0	5.5	5.0	4.5	4.5	4.0	4.0
	120	7.5	7.5	7.5	7.0	6.0	5.5	5.0	4.5	4.5	4.0	4.0
	130	7.0	7.0	7.0	6.5	6.0	5.5	5.0	4.5	4.5	4.0	4.0
	140	6.5	6.5	6.5	6.5	6.0	5.5	5.0	4.5	4.5	4.0	4.0
	150	6.0	6.0	6.0	6.0	6.0	5.5	5.0	4.5	4.5	4.0	4.0
	160	5.5	5.5	5.5	5.5	5.5	5.5	5.0	4.5	4.5	4.0	4.0
	170	5.0	5.0	5.0	5.0	5.0	5.0	5.0	4.5	4.5	4.0	4.0
	180	4.5	4.5	4.5	4.5	4.5	4.5	4.5	4.5	4.5	4.5	4.0
200	3.5	3.5	3.5	3.5	3.5	3.5	3.5	3.5	3.5	3.5	3.5	3.5

NOTE: For rails that are continuous over less than 5 modules, reduce the listed max rail span by 1 ft.

Slope 20° - 27°

Max Spans (ft)												
Zone 2*	Wind Speed (mph)	Ground Snow Load (psf)										
Exposure		0	10	20	30	40	50	60	70	80	90	100
Exp B	100	9.0	9.0	8.5	7.0	6.0	5.5	5.0	4.5	4.5	4.0	4.0
	110	9.0	9.0	8.5	7.0	6.0	5.5	5.0	4.5	4.5	4.0	4.0
	115	8.5	8.5	8.5	7.0	6.0	5.5	5.0	4.5	4.5	4.0	4.0
	120	8.0	8.0	8.0	7.0	6.0	5.5	5.0	4.5	4.5	4.0	4.0
	130	7.5	7.5	7.5	7.0	6.0	5.5	5.0	4.5	4.5	4.0	4.0
	140	7.0	7.0	7.0	7.0	6.0	5.5	5.0	4.5	4.5	4.0	4.0
	150	6.5	6.5	6.5	6.5	6.0	5.5	5.0	4.5	4.5	4.0	4.0
	160	6.0	6.0	6.0	6.0	6.0	5.5	5.0	4.5	4.5	4.0	4.0
	170	5.5	5.5	5.5	5.5	5.5	5.5	5.0	4.5	4.5	4.0	4.0
	180	5.0	5.0	5.0	5.0	5.0	5.0	5.0	4.5	4.5	4.0	4.0
200	4.0	4.0	4.0	4.0	4.0	4.0	4.0	4.0	4.0	4.0	4.0	

Max Spans (ft)												
Zone 2*	Wind Speed (mph)	Ground Snow Load (psf)										
Exposure		0	10	20	30	40	50	60	70	80	90	100
Exp C	100	8.0	8.0	8.0	7.0	6.0	5.5	5.0	4.5	4.5	4.0	4.0
	110	7.5	7.5	7.5	7.0	6.0	5.5	5.0	4.5	4.5	4.0	4.0
	115	7.0	7.0	7.0	7.0	6.0	5.5	5.0	4.5	4.5	4.0	4.0
	120	6.5	6.5	6.5	6.5	6.0	5.5	5.0	4.5	4.5	4.0	4.0
	130	6.0	6.0	6.0	6.0	6.0	5.5	5.0	4.5	4.5	4.0	4.0
	140	6.0	6.0	6.0	6.0	6.0	5.5	5.0	4.5	4.5	4.0	4.0
	150	5.5	5.5	5.5	5.5	5.5	5.5	5.0	4.5	4.5	4.0	4.0
	160	5.0	5.0	5.0	5.0	5.0	5.0	5.0	4.5	4.5	4.0	4.0
	170	4.5	4.5	4.5	4.5	4.5	4.5	4.5	4.5	4.5	4.0	4.0
	180	4.5	4.5	4.5	4.5	4.5	4.5	4.5	4.5	4.5	4.0	4.0
200	3.0	3.0	3.0	3.0	3.0	3.0	3.0	3.0	3.0	3.0	3.0	

*Zone 2 includes all zone designations (including 2e, 2n, 2r).

NOTE: For rails that are continuous over less than 5 modules, reduce the listed max rail span by 1 ft.

Slope 20° - 27°

Max Spans (ft)												
Zone 3**	Wind Speed (mph)	Ground Snow Load (psf)										
Exposure		0	10	20	30	40	50	60	70	80	90	100
Exp B	100	7.5	7.5	7.5	7.0	6.0	5.5	5.0	4.5	4.5	4.0	4.0
	110	7.0	7.0	7.0	7.0	6.0	5.5	5.0	4.5	4.5	4.0	4.0
	115	6.5	6.5	6.5	6.5	6.0	5.5	5.0	4.5	4.5	4.0	4.0
	120	6.5	6.5	6.5	6.5	6.0	5.5	5.0	4.5	4.5	4.0	4.0
	130	6.0	6.0	6.0	6.0	6.0	5.5	5.0	4.5	4.5	4.0	4.0
	140	5.5	5.5	5.5	5.5	5.5	5.5	5.0	4.5	4.5	4.0	4.0
	150	5.0	5.0	5.0	5.0	5.0	5.0	5.0	4.5	4.5	4.0	4.0
	160	4.5	4.5	4.5	4.5	4.5	4.5	4.5	4.5	4.5	4.0	4.0
	170	4.5	4.5	4.5	4.5	4.5	4.5	4.5	4.5	4.5	4.0	4.0
	180	4.0	4.0	4.0	4.0	4.0	4.0	4.0	4.0	4.0	4.0	4.0
	200	3.0	3.0	3.0	3.0	3.0	3.0	3.0	3.0	3.0	3.0	3.0

Max Spans (ft)												
Zone 3**	Wind Speed (mph)	Ground Snow Load (psf)										
Exposure		0	10	20	30	40	50	60	70	80	90	100
Exp C	100	6.5	6.5	6.5	6.0	6.0	5.5	5.0	4.5	4.5	4.0	4.0
	110	6.0	6.0	6.0	6.0	6.0	5.5	5.0	4.5	4.5	4.0	4.0
	115	6.0	6.0	6.0	6.0	6.0	5.5	5.0	4.5	4.5	4.0	4.0
	120	5.5	5.5	5.5	5.5	5.5	5.5	5.0	4.5	4.5	4.0	4.0
	130	5.0	5.0	5.0	5.0	5.0	5.0	5.0	4.5	4.5	4.0	4.0
	140	4.5	4.5	4.5	4.5	4.5	4.5	4.5	4.5	4.5	4.0	4.0
	150	4.0	4.0	4.0	4.0	4.0	4.0	4.0	4.0	4.0	4.0	4.0
	160	4.0	4.0	4.0	4.0	4.0	4.0	4.0	4.0	4.0	4.0	4.0
	170	3.5	3.5	3.5	3.5	3.5	3.5	3.5	3.5	3.5	3.5	3.5
	180	3.5	3.5	3.5	3.5	3.5	3.5	3.5	3.5	3.5	3.5	3.5
	200	2.0	2.0	2.0	2.0	2.0	2.0	2.0	2.0	2.0	2.0	2.0

**Zone 3 includes all zone designations (including 3, 3e & 3r).

NOTE: For rails that are continuous over less than 5 modules, reduce the listed max rail span by 1 ft.

Slope 27° - 45°

Max Spans (ft)												
Zone 1	Wind Speed (mph)	Ground Snow Load (psf)										
Exposure		0	10	20	30	40	50	60	70	80	90	100
Exp B	100	9.0	9.0	9.0	8.0	7.0	6.0	6.0	5.0	5.0	4.5	4.5
	110	9.0	9.0	9.0	8.0	7.0	6.0	6.0	5.0	5.0	4.5	4.5
	115	9.0	9.0	9.0	8.0	7.0	6.0	6.0	5.0	5.0	4.5	4.5
	120	9.0	9.0	8.5	8.0	7.0	6.0	6.0	5.0	5.0	4.5	4.5
	130	9.0	8.5	8.0	7.5	7.0	6.0	6.0	5.0	5.0	4.5	4.5
	140	8.5	8.0	7.5	7.5	7.0	6.0	6.0	5.0	5.0	4.5	4.5
	150	8.0	7.5	7.5	7.0	6.5	6.0	6.0	5.0	5.0	4.5	4.5
	160	7.5	7.5	7.0	6.5	6.5	6.0	6.0	5.0	5.0	4.5	4.5
	170	7.0	7.0	6.5	6.0	6.0	6.0	6.0	5.0	5.0	4.5	4.5
	180	6.5	6.5	6.0	6.0	6.0	6.0	5.5	5.0	5.0	4.5	4.5
200	5.0	5.0	5.0	5.0	5.0	5.0	5.0	5.0	5.0	4.5	4.5	

Max Spans (ft)												
Zone 1	Wind Speed (mph)	Ground Snow Load (psf)										
Exposure		0	10	20	30	40	50	60	70	80	90	100
Exp C	100	9.0	9.0	8.5	7.5	7.0	6.0	6.0	5.0	5.0	4.5	4.5
	110	9.0	8.5	8.0	7.5	7.0	6.0	6.0	5.0	5.0	4.5	4.5
	115	8.5	8.0	8.0	7.5	7.0	6.0	6.0	5.0	5.0	4.5	4.5
	120	8.0	8.0	7.5	7.5	7.0	6.0	6.0	5.0	5.0	4.5	4.5
	130	7.5	7.5	7.0	7.0	6.5	6.0	6.0	5.0	5.0	4.5	4.5
	140	7.0	7.0	6.5	6.5	6.5	6.0	6.0	5.0	5.0	4.5	4.5
	150	6.5	6.5	6.5	6.5	6.0	6.0	5.5	5.0	5.0	4.5	4.5
	160	6.0	6.0	6.0	6.0	6.0	6.0	5.5	5.0	5.0	4.5	4.5
	170	5.5	5.5	5.5	5.5	5.5	5.5	5.0	5.0	5.0	4.5	4.5
	180	5.5	5.5	5.5	5.5	5.0	5.0	5.0	5.0	4.5	4.5	4.5
200	4.5	4.5	4.5	4.5	4.5	4.5	4.5	4.5	4.5	4.5	4.5	

NOTE: For rails that are continuous over less than 5 modules, reduce the listed max rail span by 1 ft.

Slope 27° - 45°

Max Spans (ft)												
Zone 2*	Wind Speed (mph)	Ground Snow Load (psf)										
Exposure		0	10	20	30	40	50	60	70	80	90	100
Exp B	100	9.0	9.0	9.0	8.0	7.0	6.0	6.0	5.0	5.0	4.5	4.5
	110	9.0	9.0	9.0	8.0	7.0	6.0	6.0	5.0	5.0	4.5	4.5
	115	9.0	9.0	8.5	8.0	7.0	6.0	6.0	5.0	5.0	4.5	4.5
	120	8.5	8.5	8.0	8.0	7.0	6.0	6.0	5.0	5.0	4.5	4.5
	130	8.0	8.0	7.5	7.5	7.0	6.0	6.0	5.0	5.0	4.5	4.5
	140	7.5	7.5	7.5	7.5	7.0	6.0	6.0	5.0	5.0	4.5	4.5
	150	7.0	7.0	7.0	7.0	6.5	6.0	6.0	5.0	5.0	4.5	4.5
	160	6.0	6.0	6.0	6.0	6.5	6.0	6.0	5.0	5.0	4.5	4.5
	170	5.5	5.5	5.5	5.5	5.5	5.5	5.5	5.0	5.0	4.5	4.5
	180	5.0	5.0	5.0	5.0	5.0	5.0	5.0	5.0	5.0	4.5	4.5
200	4.0	4.0	4.0	4.0	4.0	4.0	4.0	4.0	4.0	4.0	4.0	

Max Spans (ft)												
Zone 2*	Wind Speed (mph)	Ground Snow Load (psf)										
Exposure		0	10	20	30	40	50	60	70	80	90	100
Exp C	100	8.5	8.5	8.5	7.5	7.0	6.0	6.0	5.0	5.0	4.5	4.5
	110	8.0	8.0	8.0	7.5	7.0	6.0	6.0	5.0	5.0	4.5	4.5
	115	7.5	7.5	7.5	7.5	7.0	6.0	6.0	5.0	5.0	4.5	4.5
	120	7.0	7.0	7.0	7.0	7.0	6.0	6.0	5.0	5.0	4.5	4.5
	130	6.5	6.5	6.5	6.5	6.5	6.0	6.0	5.0	5.0	4.5	4.5
	140	6.0	6.0	6.0	6.0	6.0	6.0	6.0	5.0	5.0	4.5	4.5
	150	5.5	5.5	5.5	5.5	5.5	5.5	5.5	5.0	5.0	4.5	4.5
	160	5.0	5.0	5.0	5.0	5.0	5.0	5.0	5.0	5.0	4.5	4.5
	170	4.5	4.5	4.5	4.5	4.5	4.5	4.5	4.5	4.5	4.5	4.5
	180	4.0	4.0	4.0	4.0	4.0	4.0	4.0	4.0	4.0	4.0	4.0
200	3.0	3.0	3.0	3.0	3.0	3.0	3.0	3.0	3.0	3.0	3.0	

*Zone 2 includes all zone designations (including 2e, 2n, 2r).

Slope 27° - 45°

Max Spans (ft)												
Zone 3**	Wind Speed (mph)	Ground Snow Load (psf)										
Exposure		0	10	20	30	40	50	60	70	80	90	100
Exp B	100	9.0	9.0	9.0	8.0	7.0	6.0	6.0	5.0	5.0	4.5	4.5
	110	8.5	8.5	8.5	8.0	7.0	6.0	6.0	5.0	5.0	4.5	4.5
	115	8.0	8.0	8.0	8.0	7.0	6.0	6.0	5.0	5.0	4.5	4.5
	120	7.5	7.5	7.5	7.5	7.0	6.0	6.0	5.0	5.0	4.5	4.5
	130	7.0	7.0	7.0	7.0	7.0	6.0	6.0	5.0	5.0	4.5	4.5
	140	6.5	6.5	6.5	6.5	6.5	6.0	6.0	5.0	5.0	4.5	4.5
	150	6.0	6.0	6.0	6.0	6.0	6.0	6.0	5.0	5.0	4.5	4.5
	160	5.5	5.5	5.5	5.5	5.5	5.5	5.5	5.0	5.0	4.5	4.5
	170	5.0	5.0	5.0	5.0	5.0	5.0	5.0	5.0	5.0	4.5	4.5
	180	4.5	4.5	4.5	4.5	4.5	4.5	4.5	4.5	4.5	4.5	4.5
200	4.0	4.0	4.0	4.0	4.0	4.0	4.0	4.0	4.0	4.0	4.0	

Max Spans (ft)												
Zone 3**	Wind Speed (mph)	Ground Snow Load (psf)										
Exposure		0	10	20	30	40	50	60	70	80	90	100
Exp C	100	8.0	8.0	8.0	7.5	7.0	6.0	6.0	5.0	5.0	4.5	4.5
	110	7.5	7.5	7.5	7.5	7.0	6.0	6.0	5.0	5.0	4.5	4.5
	115	7.0	7.0	7.0	7.0	7.0	6.0	6.0	5.0	5.0	4.5	4.5
	120	6.5	6.5	6.5	6.5	6.5	6.0	6.0	5.0	5.0	4.5	4.5
	130	6.0	6.0	6.0	6.0	6.0	6.0	6.0	5.0	5.0	4.5	4.5
	140	5.5	5.5	5.5	5.5	5.5	5.5	5.5	5.0	5.0	4.5	4.5
	150	5.0	5.0	5.0	5.0	5.0	5.0	5.0	5.0	5.0	4.5	4.5
	160	4.5	4.5	4.5	4.5	4.5	4.5	4.5	4.5	4.5	4.5	4.5
	170	4.0	4.0	4.0	4.0	4.0	4.0	4.0	4.0	4.0	4.0	4.0
	180	3.5	3.5	3.5	3.5	3.5	3.5	3.5	3.5	3.5	3.5	3.5
200	3.0	3.0	3.0	3.0	3.0	3.0	3.0	3.0	3.0	3.0	3.0	

**Zone 3 includes all zone designations (including 3, 3e & 3r).

NOTE: For rails that are continuous over less than 5 modules, reduce the listed max rail span by 1 ft.

Slope 0° -7°

Max Spans (ft)												
Zone 1'	Wind Speed (mph)	Ground Snow Load (psf)										
Exposure		0	10	20	30	40	50	60	70	80	90	100
Exp B	100	9.0	9.0	8.0	6.5	6.0	5.5	5.0	4.5	4.0	4.0	3.5
	110	9.0	9.0	8.0	6.5	6.0	5.5	5.0	4.5	4.0	4.0	3.5
	115	9.0	9.0	8.0	6.5	6.0	5.5	5.0	4.5	4.0	4.0	3.5
	120	9.0	9.0	8.0	6.5	6.0	5.5	5.0	4.5	4.0	4.0	3.5
	130	9.0	9.0	8.0	6.5	6.0	5.5	5.0	4.5	4.0	4.0	3.5
	140	9.0	9.0	8.0	6.5	6.0	5.5	5.0	4.5	4.0	4.0	3.5
	150	8.0	8.0	8.0	6.5	6.0	5.5	5.0	4.5	4.0	4.0	3.5
	160	7.5	7.5	7.5	6.5	6.0	5.5	5.0	4.5	4.0	4.0	3.5
	170	7.0	7.0	7.0	6.5	6.0	5.5	5.0	4.5	4.0	4.0	3.5
	180	6.5	6.5	6.5	6.5	6.0	5.5	5.0	4.5	4.0	4.0	3.5
200	5.5	5.5	5.5	5.5	5.5	5.5	5.0	4.5	4.0	4.0	3.5	

Max Spans (ft)												
Zone 1'	Wind Speed (mph)	Ground Snow Load (psf)										
Exposure		0	10	20	30	40	50	60	70	80	90	100
Exp C	100	9.0	9.0	8.0	6.5	6.0	5.5	5.0	4.5	4.0	4.0	3.5
	110	9.0	9.0	8.0	6.5	6.0	5.5	5.0	4.5	4.0	4.0	3.5
	115	9.0	9.0	8.0	6.5	6.0	5.5	5.0	4.5	4.0	4.0	3.5
	120	8.5	8.5	8.0	6.5	6.0	5.5	5.0	4.5	4.0	4.0	3.5
	130	8.0	8.0	8.0	6.5	6.0	5.5	5.0	4.5	4.0	4.0	3.5
	140	7.5	7.5	7.5	6.5	6.0	5.5	5.0	4.5	4.0	4.0	3.5
	150	7.0	7.0	7.0	6.5	6.0	5.5	5.0	4.5	4.0	4.0	3.5
	160	6.5	6.5	6.5	6.5	6.0	5.5	5.0	4.5	4.0	4.0	3.5
	170	6.0	6.0	6.0	6.0	6.0	5.5	5.0	4.5	4.0	4.0	3.5
	180	6.0	6.0	6.0	6.0	6.0	5.5	5.0	4.5	4.0	4.0	3.5
200	4.5	4.5	4.5	4.5	4.5	4.5	4.5	4.5	4.0	4.0	3.5	

NOTE: For rails that are continuous over less than 5 modules, reduce the listed max rail span by 1 ft.

Slope 0° -7°

Max Spans (ft)												
Zone 1 & 2	Wind Speed (mph)	Ground Snow Load (psf)										
Exposure		0	10	20	30	40	50	60	70	80	90	100
Exp B	100	8.5	8.5	8.0	6.5	6.0	5.5	5.0	4.5	4.0	4.0	3.5
	110	8.0	8.0	8.0	6.5	6.0	5.5	5.0	4.5	4.0	4.0	3.5
	115	7.5	7.5	7.5	6.5	6.0	5.5	5.0	4.5	4.0	4.0	3.5
	120	7.0	7.0	7.0	6.5	6.0	5.5	5.0	4.5	4.0	4.0	3.5
	130	6.5	6.5	6.5	6.5	6.0	5.5	5.0	4.5	4.0	4.0	3.5
	140	6.0	6.0	6.0	6.0	6.0	5.5	5.0	4.5	4.0	4.0	3.5
	150	5.5	5.5	5.5	5.5	5.5	5.5	5.0	4.5	4.0	4.0	3.5
	160	5.5	5.5	5.5	5.5	5.5	5.5	5.0	4.5	4.0	4.0	3.5
	170	5.0	5.0	5.0	5.0	5.0	5.0	5.0	4.5	4.0	4.0	3.5
	180	4.5	4.5	4.5	4.5	4.5	4.5	4.5	4.5	4.0	4.0	3.5
200	3.5	3.5	3.5	3.5	3.5	3.5	3.5	3.5	3.5	3.5	3.5	

Max Spans (ft)												
Zone 1 & 2	Wind Speed (mph)	Ground Snow Load (psf)										
Exposure		0	10	20	30	40	50	60	70	80	90	100
Exp C	100	7.0	7.0	7.0	6.5	6.0	5.5	5.0	4.5	4.0	4.0	3.5
	110	6.5	6.5	6.5	6.5	6.0	5.5	5.0	4.5	4.0	4.0	3.5
	115	6.0	6.0	6.0	6.0	6.0	5.5	5.0	4.5	4.0	4.0	3.5
	120	6.0	6.0	6.0	6.0	6.0	5.5	5.0	4.5	4.0	4.0	3.5
	130	5.5	5.5	5.5	5.5	5.5	5.5	5.0	4.5	4.0	4.0	3.5
	140	5.0	5.0	5.0	5.0	5.0	5.5	5.0	4.5	4.0	4.0	3.5
	150	5.0	5.0	5.0	5.0	5.0	5.0	5.0	4.5	4.0	4.0	3.5
	160	4.5	4.5	4.5	4.5	4.5	4.5	4.5	4.5	4.0	4.0	3.5
	170	4.5	4.5	4.5	4.5	4.5	4.5	4.5	4.5	4.0	4.0	3.5
	180	4.0	4.0	4.0	4.0	4.0	4.0	4.0	4.0	4.0	4.0	3.5
200	3.0	3.0	3.0	3.0	3.0	3.0	3.0	3.0	3.0	3.0	3.0	

NOTE: For rails that are continuous over less than 5 modules, reduce the listed max rail span by 1 ft.

Slope 0° -7°

Max Spans (ft)												
Zone 3	Wind Speed (mph)	Ground Snow Load (psf)										
Exposure		0	10	20	30	40	50	60	70	80	90	100
Exp B	100	7.0	7.0	7.0	6.5	6.0	5.5	5.0	4.5	4.0	4.0	3.5
	110	6.5	6.5	6.5	6.5	6.0	5.5	5.0	4.5	4.0	4.0	3.5
	115	6.5	6.5	6.5	6.5	6.0	5.5	5.0	4.5	4.0	4.0	3.5
	120	6.0	6.0	6.0	6.0	6.0	5.5	5.0	4.5	4.0	4.0	3.5
	130	5.5	5.5	5.5	5.5	5.5	5.5	5.0	4.5	4.0	4.0	3.5
	140	5.0	5.0	5.0	5.0	5.0	5.0	5.0	4.5	4.0	4.0	3.5
	150	4.5	4.5	4.5	4.5	4.5	4.5	4.5	4.5	4.0	4.0	3.5
	160	4.5	4.5	4.5	4.5	4.5	4.5	4.5	4.5	4.0	4.0	3.5
	170	4.0	4.0	4.0	4.0	4.0	4.0	4.0	4.0	4.0	4.0	3.5
	180	4.0	4.0	4.0	4.0	4.0	4.0	4.0	4.0	4.0	4.0	3.5
200	2.5	2.5	2.5	2.5	2.5	2.5	2.5	2.5	2.5	2.5	2.5	

Max Spans (ft)												
Zone 3	Wind Speed (mph)	Ground Snow Load (psf)										
Exposure		0	10	20	30	40	50	60	70	80	90	100
Exp C	100	6.0	6.0	6.0	5.5	5.5	5.5	5.0	4.5	4.0	4.0	3.5
	110	5.5	5.5	5.5	5.5	5.5	5.5	5.0	4.5	4.0	4.0	3.5
	115	5.5	5.5	5.5	5.5	5.5	5.5	5.0	4.5	4.0	4.0	3.5
	120	5.0	5.0	5.0	5.0	5.0	5.0	5.0	4.5	4.0	4.0	3.5
	130	4.5	4.5	4.5	4.5	4.5	4.5	4.5	4.5	4.0	4.0	3.5
	140	4.5	4.5	4.5	4.5	4.5	4.5	4.5	4.5	4.0	4.0	3.5
	150	4.0	4.0	4.0	4.0	4.0	4.0	4.0	4.0	4.0	4.0	3.5
	160	3.5	3.5	3.5	3.5	3.5	3.5	3.5	3.5	3.5	3.5	3.5
	170	3.5	3.5	3.5	3.5	3.5	3.5	3.5	3.5	3.5	3.5	3.5
	180	3.5	3.5	3.5	3.5	3.5	3.5	3.5	3.5	3.5	3.5	3.5
200	2.0	2.0	2.0	2.0	2.0	2.0	2.0	2.0	2.0	2.0	2.0	

NOTE: For rails that are continuous over less than 5 modules, reduce the listed max rail span by 1 ft.

Slope 7° - 20°

Max Spans (ft)												
Zone 1	Wind Speed (mph)	Ground Snow Load (psf)										
Exposure		0	10	20	30	40	50	60	70	80	90	100
Exp B	100	9.0	9.0	8.0	6.5	6.0	5.5	5.0	4.5	4.0	4.0	3.5
	110	9.0	9.0	8.0	6.5	6.0	5.5	5.0	4.5	4.0	4.0	3.5
	115	8.5	8.5	8.0	6.5	6.0	5.5	5.0	4.5	4.0	4.0	3.5
	120	8.0	8.0	8.0	6.5	6.0	5.5	5.0	4.5	4.0	4.0	3.5
	130	7.5	7.5	7.5	6.5	6.0	5.5	5.0	4.5	4.0	4.0	3.5
	140	7.0	7.0	7.0	6.5	6.0	5.5	5.0	4.5	4.0	4.0	3.5
	150	6.5	6.5	6.5	6.5	6.0	5.5	5.0	4.5	4.0	4.0	3.5
	160	6.0	6.0	6.0	6.0	6.0	5.5	5.0	4.5	4.0	4.0	3.5
	170	5.5	5.5	5.5	5.5	5.5	5.5	5.0	4.5	4.0	4.0	3.5
	180	5.0	5.0	5.0	5.0	5.0	5.0	5.0	4.5	4.0	4.0	3.5
200	4.5	4.5	4.5	4.5	4.5	4.5	4.5	4.5	4.5	4.0	4.0	3.5

Max Spans (ft)												
Zone 1	Wind Speed (mph)	Ground Snow Load (psf)										
Exposure		0	10	20	30	40	50	60	70	80	90	100
Exp C	100	9.0	9.0	7.5	6.5	6.0	5.5	5.0	4.5	4.0	4.0	3.5
	110	8.0	8.0	7.5	6.5	6.0	5.5	5.0	4.5	4.0	4.0	3.5
	115	7.5	7.5	7.5	6.5	6.0	5.5	5.0	4.5	4.0	4.0	3.5
	120	7.0	7.0	7.0	6.5	6.0	5.5	5.0	4.5	4.0	4.0	3.5
	130	6.5	6.5	6.5	6.5	6.0	5.5	5.0	4.5	4.0	4.0	3.5
	140	6.0	6.0	6.0	6.0	6.0	5.5	5.0	4.5	4.0	4.0	3.5
	150	5.5	5.5	5.5	5.5	5.5	5.5	5.0	4.5	4.0	4.0	3.5
	160	5.0	5.0	5.0	5.0	5.0	5.0	5.0	4.5	4.0	4.0	3.5
	170	5.0	5.0	5.0	5.0	5.0	5.0	4.5	4.5	4.0	4.0	3.5
	180	4.5	4.5	4.5	4.5	4.5	4.5	4.5	4.5	4.0	4.0	3.5
200	4.0	4.0	4.0	4.0	4.0	4.0	4.0	4.0	4.0	4.0	4.0	3.5

NOTE: For rails that are continuous over less than 5 modules, reduce the listed max rail span by 1 ft.

Slope 7° - 20°

Max Spans (ft)												
Zone 2*	Wind Speed (mph)	Ground Snow Load (psf)										
Exposure		0	10	20	30	40	50	60	70	80	90	100
Exp B	100	8.5	8.5	8.0	6.5	6.0	5.5	5.0	4.5	4.0	4.0	3.5
	110	8.0	8.0	8.0	6.5	6.0	5.5	5.0	4.5	4.0	4.0	3.5
	115	7.5	7.5	7.5	6.5	6.0	5.5	5.0	4.5	4.0	4.0	3.5
	120	7.5	7.5	7.5	6.5	6.0	5.5	5.0	4.5	4.0	4.0	3.5
	130	6.5	6.5	6.5	6.5	6.0	5.5	5.0	4.5	4.0	4.0	3.5
	140	6.0	6.0	6.0	6.0	6.0	5.5	5.0	4.5	4.0	4.0	3.5
	150	5.5	5.5	5.5	5.5	5.5	5.5	5.0	4.5	4.0	4.0	3.5
	160	5.5	5.5	5.5	5.5	5.5	5.5	5.0	4.5	4.0	4.0	3.5
	170	5.0	5.0	5.0	5.0	5.0	5.0	5.0	4.5	4.0	4.0	3.5
	180	4.5	4.5	4.5	4.5	4.5	4.5	4.5	4.5	4.0	4.0	3.5
200	3.5	3.5	3.5	3.5	3.5	3.5	3.5	3.5	3.5	3.5	3.5	

Max Spans (ft)												
Zone 2*	Wind Speed (mph)	Ground Snow Load (psf)										
Exposure		0	10	20	30	40	50	60	70	80	90	100
Exp C	100	7.0	7.0	7.0	6.5	6.0	5.5	5.0	4.5	4.0	4.0	3.5
	110	6.5	6.5	6.5	6.5	6.0	5.5	5.0	4.5	4.0	4.0	3.5
	115	6.5	6.5	6.5	6.5	6.0	5.5	5.0	4.5	4.0	4.0	3.5
	120	6.0	6.0	6.0	6.0	6.0	5.5	5.0	4.5	4.0	4.0	3.5
	130	5.5	5.5	5.5	5.5	5.5	5.5	5.0	4.5	4.0	4.0	3.5
	140	5.0	5.0	5.0	5.0	5.0	5.0	5.0	4.5	4.0	4.0	3.5
	150	4.5	4.5	4.5	4.5	4.5	4.5	4.5	4.5	4.0	4.0	3.5
	160	4.5	4.5	4.5	4.5	4.5	4.5	4.5	4.5	4.0	4.0	3.5
	170	4.0	4.0	4.0	4.0	4.0	4.0	4.0	4.0	4.0	4.0	3.5
	180	3.5	3.5	3.5	3.5	3.5	3.5	3.5	3.5	3.5	3.5	3.5
200	2.5	2.5	2.5	2.5	2.5	2.5	2.5	2.5	2.5	2.5	2.5	

*Zone 2 includes all zone designations (including 2e, 2n, 2r).

NOTE: For rails that are continuous over less than 5 modules, reduce the listed max rail span by 1 ft.

Slope 7° - 20°

Max Spans (ft)												
Zone 3**	Wind Speed (mph)	Ground Snow Load (psf)										
Exposure		0	10	20	30	40	50	60	70	80	90	100
Exp B	100	7.5	7.5	7.0	6.5	6.0	5.5	5.0	4.5	4.0	4.0	3.5
	110	7.0	7.0	7.0	6.5	6.0	5.5	5.0	4.5	4.0	4.0	3.5
	115	6.5	6.5	6.5	6.5	6.0	5.5	5.0	4.5	4.0	4.0	3.5
	120	6.5	6.5	6.5	6.5	6.0	5.5	5.0	4.5	4.0	4.0	3.5
	130	6.0	6.0	6.0	6.0	6.0	5.5	5.0	4.5	4.0	4.0	3.5
	140	5.5	5.5	5.5	5.5	5.5	5.5	5.0	4.5	4.0	4.0	3.5
	150	5.0	5.0	5.0	5.0	5.0	5.0	5.0	4.5	4.0	4.0	3.5
	160	4.5	4.5	4.5	4.5	4.5	4.5	4.5	4.5	4.0	4.0	3.5
	170	4.5	4.5	4.5	4.5	4.5	4.5	4.5	4.5	4.0	4.0	3.5
	180	4.0	4.0	4.0	4.0	4.0	4.0	4.0	4.0	4.0	4.0	3.5
	200	3.0	3.0	3.0	3.0	3.0	3.0	3.0	3.0	3.0	3.0	3.0

Max Spans (ft)												
Zone 3**	Wind Speed (mph)	Ground Snow Load (psf)										
Exposure		0	10	20	30	40	50	60	70	80	90	100
Exp C	100	6.5	6.5	6.5	6.0	6.0	5.5	5.0	4.5	4.0	4.0	3.5
	110	6.0	6.0	6.0	6.0	6.0	5.5	5.0	4.5	4.0	4.0	3.5
	115	5.5	5.5	5.5	5.5	5.5	5.5	5.0	4.5	4.0	4.0	3.5
	120	5.5	5.5	5.5	5.5	5.5	5.5	5.0	4.5	4.0	4.0	3.5
	130	5.0	5.0	5.0	5.0	5.0	5.0	5.0	4.5	4.0	4.0	3.5
	140	4.5	4.5	4.5	4.5	4.5	4.5	4.5	4.5	4.0	4.0	3.5
	150	4.0	4.0	4.0	4.0	4.0	4.0	4.0	4.0	4.0	4.0	3.5
	160	4.0	4.0	4.0	4.0	4.0	4.0	4.0	4.0	4.0	4.0	3.5
	170	3.5	3.5	3.5	3.5	3.5	3.5	3.5	3.5	3.5	3.5	3.5
	180	3.5	3.5	3.5	3.5	3.5	3.5	3.5	3.5	3.5	3.5	3.5
	200	2.0	2.0	2.0	2.0	2.0	2.0	2.0	2.0	2.0	2.0	2.0

**Zone 3 includes all zone designations (including 3, 3e & 3r).

NOTE: For rails that are continuous over less than 5 modules, reduce the listed max rail span by 1 ft.

Slope 20° - 27°

Max Spans (ft)												
Zone 1	Wind Speed (mph)	Ground Snow Load (psf)										
Exposure		0	10	20	30	40	50	60	70	80	90	100
Exp B	100	9.0	9.0	8.0	6.5	6.0	5.5	5.0	4.5	4.0	4.0	3.5
	110	9.0	9.0	8.0	6.5	6.0	5.5	5.0	4.5	4.0	4.0	3.5
	115	9.0	9.0	8.0	6.5	6.0	5.5	5.0	4.5	4.0	4.0	3.5
	120	8.5	8.5	8.0	6.5	6.0	5.5	5.0	4.5	4.0	4.0	3.5
	130	8.0	8.0	7.5	6.5	6.0	5.5	5.0	4.5	4.0	4.0	3.5
	140	7.5	7.5	7.0	6.5	6.0	5.5	5.0	4.5	4.0	4.0	3.5
	150	7.0	7.0	7.0	6.5	6.0	5.5	5.0	4.5	4.0	4.0	3.5
	160	6.5	6.5	6.5	6.5	6.0	5.5	5.0	4.5	4.0	4.0	3.5
	170	6.0	6.0	6.0	6.0	6.0	5.5	5.0	4.5	4.0	4.0	3.5
	180	5.5	5.5	5.5	5.5	5.5	5.0	5.0	4.5	4.0	4.0	3.5
200	4.5	4.5	4.5	4.5	4.5	4.5	4.5	4.5	4.5	4.0	4.0	3.5

Max Spans (ft)												
Zone 1	Wind Speed (mph)	Ground Snow Load (psf)										
Exposure		0	10	20	30	40	50	60	70	80	90	100
Exp C	100	9.0	9.0	8.0	6.5	6.0	5.5	5.0	4.5	4.0	4.0	3.5
	110	8.5	8.5	7.5	6.5	6.0	5.5	5.0	4.5	4.0	4.0	3.5
	115	8.0	8.0	7.5	6.5	6.0	5.5	5.0	4.5	4.0	4.0	3.5
	120	7.5	7.5	7.5	6.5	6.0	5.5	5.0	4.5	4.0	4.0	3.5
	130	7.0	7.0	7.0	6.5	6.0	5.5	5.0	4.5	4.0	4.0	3.5
	140	7.0	7.0	7.0	6.5	6.0	5.5	5.0	4.5	4.0	4.0	3.5
	150	6.0	6.0	6.0	6.0	6.0	5.5	5.0	4.5	4.0	4.0	3.5
	160	5.5	5.5	5.5	5.5	5.5	5.0	5.0	4.5	4.0	4.0	3.5
	170	5.5	5.5	5.5	5.5	5.5	5.0	4.5	4.5	4.0	4.0	3.5
	180	5.0	5.0	5.0	5.0	5.0	5.0	4.5	4.5	4.0	4.0	3.5
200	4.0	4.0	4.0	4.0	4.0	4.0	4.0	4.0	4.0	4.0	4.0	3.5

NOTE: For rails that are continuous over less than 5 modules, reduce the listed max rail span by 1 ft.

Slope 20° - 27°

Max Spans (ft)												
Zone 2*	Wind Speed (mph)	Ground Snow Load (psf)										
Exposure		0	10	20	30	40	50	60	70	80	90	100
Exp B	100	9.0	9.0	8.0	6.5	6.0	5.5	5.0	4.5	4.0	4.0	3.5
	110	8.5	8.5	8.0	6.5	6.0	5.5	5.0	4.5	4.0	4.0	3.5
	115	8.0	8.0	8.0	6.5	6.0	5.5	5.0	4.5	4.0	4.0	3.5
	120	8.0	8.0	8.0	6.5	6.0	5.5	5.0	4.5	4.0	4.0	3.5
	130	7.0	7.0	7.0	6.5	6.0	5.5	5.0	4.5	4.0	4.0	3.5
	140	6.5	6.5	6.5	6.5	6.0	5.5	5.0	4.5	4.0	4.0	3.5
	150	6.0	6.0	6.0	6.0	6.0	5.5	5.0	4.5	4.0	4.0	3.5
	160	6.0	6.0	6.0	6.0	6.0	5.5	5.0	4.5	4.0	4.0	3.5
	170	5.5	5.5	5.5	5.5	5.5	5.5	5.0	4.5	4.0	4.0	3.5
	180	5.0	5.0	5.0	5.0	5.0	5.0	5.0	4.5	4.0	4.0	3.5
	200	4.0	4.0	4.0	4.0	4.0	4.0	4.0	4.0	4.0	4.0	3.5

Max Spans (ft)												
Zone 2*	Wind Speed (mph)	Ground Snow Load (psf)										
Exposure		0	10	20	30	40	50	60	70	80	90	100
Exp C	100	7.5	7.5	7.0	6.5	6.0	5.5	5.0	4.5	4.0	4.0	3.5
	110	7.0	7.0	7.0	6.5	6.0	5.5	5.0	4.5	4.0	4.0	3.5
	115	7.0	7.0	7.0	6.5	6.0	5.5	5.0	4.5	4.0	4.0	3.5
	120	6.5	6.5	6.5	6.5	6.0	5.5	5.0	4.5	4.0	4.0	3.5
	130	6.0	6.0	6.0	6.0	6.0	5.5	5.0	4.5	4.0	4.0	3.5
	140	5.5	5.5	5.5	5.5	5.5	5.5	5.0	4.5	4.0	4.0	3.5
	150	5.0	5.0	5.0	5.0	5.0	5.0	5.0	4.5	4.0	4.0	3.5
	160	5.0	5.0	5.0	5.0	5.0	5.0	5.0	4.5	4.0	4.0	3.5
	170	4.5	4.5	4.5	4.5	4.5	4.5	4.5	4.5	4.0	4.0	3.5
	180	4.0	4.0	4.0	4.0	4.0	4.0	4.0	4.0	4.0	4.0	3.5
	200	3.0	3.0	3.0	3.0	3.0	3.0	3.0	3.0	3.0	3.0	3.0

*Zone 2 includes all zone designations (including 2e, 2n, 2r).

Slope 20° - 27°

Max Spans (ft)												
Zone 3**	Wind Speed (mph)	Ground Snow Load (psf)										
Exposure		0	10	20	30	40	50	60	70	80	90	100
Exp B	100	7.5	7.5	7.5	6.5	6.0	5.5	5.0	4.5	4.0	4.0	3.5
	110	7.0	7.0	7.0	6.5	6.0	5.5	5.0	4.5	4.0	4.0	3.5
	115	6.5	6.5	6.5	6.5	6.0	5.5	5.0	4.5	4.0	4.0	3.5
	120	6.5	6.5	6.5	6.5	6.0	5.5	5.0	4.5	4.0	4.0	3.5
	130	6.0	6.0	6.0	6.0	6.0	5.5	5.0	4.5	4.0	4.0	3.5
	140	5.5	5.5	5.5	5.5	5.5	5.5	5.0	4.5	4.0	4.0	3.5
	150	5.0	5.0	5.0	5.0	5.0	5.0	5.0	4.5	4.0	4.0	3.5
	160	4.5	4.5	4.5	4.5	4.5	4.5	4.5	4.5	4.0	4.0	3.5
	170	4.5	4.5	4.5	4.5	4.5	4.5	4.5	4.5	4.0	4.0	3.5
	180	4.0	4.0	4.0	4.0	4.0	4.0	4.0	4.0	4.0	4.0	3.5
	200	3.0	3.0	3.0	3.0	3.0	3.0	3.0	3.0	3.0	3.0	3.0

Max Spans (ft)												
Zone 3**	Wind Speed (mph)	Ground Snow Load (psf)										
Exposure		0	10	20	30	40	50	60	70	80	90	100
Exp C	100	6.5	6.5	6.5	6.0	6.0	5.5	5.0	4.5	4.0	4.0	3.5
	110	6.0	6.0	6.0	6.0	6.0	5.5	5.0	4.5	4.0	4.0	3.5
	115	5.5	5.5	5.5	5.5	5.5	5.5	5.0	4.5	4.0	4.0	3.5
	120	5.5	5.5	5.5	5.5	5.5	5.5	5.0	4.5	4.0	4.0	3.5
	130	5.0	5.0	5.0	5.0	5.0	5.0	5.0	4.5	4.0	4.0	3.5
	140	4.5	4.5	4.5	4.5	4.5	4.5	4.5	4.5	4.0	4.0	3.5
	150	4.0	4.0	4.0	4.0	4.0	4.0	4.0	4.0	4.0	4.0	3.5
	160	4.0	4.0	4.0	4.0	4.0	4.0	4.0	4.0	4.0	4.0	3.5
	170	3.5	3.5	3.5	3.5	3.5	3.5	3.5	3.5	3.5	3.5	3.5
	180	3.5	3.5	3.5	3.5	3.5	3.5	3.5	3.5	3.5	3.5	3.5
	200	2.0	2.0	2.0	2.0	2.0	2.0	2.0	2.0	2.0	2.0	2.0

**Zone 3 includes all zone designations (including 3, 3e & 3r).

NOTE: For rails that are continuous over less than 5 modules, reduce the listed max rail span by 1 ft.

Slope 27° - 45°

Max Spans (ft)												
Zone 1	Wind Speed (mph)	Ground Snow Load (psf)										
Exposure		0	10	20	30	40	50	60	70	80	90	100
Exp B	100	9.0	9.0	7.5	6.5	6.0	5.5	5.0	4.5	4.5	4.5	4.0
	110	9.0	8.5	7.5	6.5	6.0	5.5	5.0	4.5	4.5	4.5	4.0
	115	9.0	8.0	7.5	6.5	6.0	5.5	5.0	4.5	4.5	4.0	4.0
	120	9.0	8.0	7.0	6.5	6.0	5.5	5.0	4.5	4.5	4.0	4.0
	130	9.0	7.5	7.0	6.0	6.0	5.5	5.0	4.5	4.5	4.0	4.0
	140	8.5	7.0	7.0	6.0	6.0	5.0	5.0	4.5	4.5	4.0	4.0
	150	7.5	7.0	6.5	6.0	5.5	5.0	4.5	4.5	4.5	4.0	4.0
	160	7.0	6.5	6.5	6.0	5.5	5.0	4.5	4.5	4.0	4.0	4.0
	170	6.5	6.5	6.0	6.0	5.0	5.0	4.5	4.5	4.0	4.0	4.0
	180	6.0	6.0	6.0	5.5	5.0	4.5	4.5	4.5	4.0	4.0	3.5
200	5.0	5.0	5.0	5.0	5.0	4.5	4.5	4.5	4.0	4.0	3.5	

Max Spans (ft)												
Zone 1	Wind Speed (mph)	Ground Snow Load (psf)										
Exposure		0	10	20	30	40	50	60	70	80	90	100
Exp C	100	9.0	8.0	7.0	6.0	6.0	5.5	5.0	4.5	4.5	4.0	4.0
	110	9.0	7.5	7.0	6.0	6.0	5.5	5.0	4.5	4.5	4.0	4.0
	115	9.0	7.5	7.0	6.0	6.0	5.0	5.0	4.5	4.5	4.0	4.0
	120	8.5	7.0	6.5	6.0	5.5	5.0	5.0	4.5	4.5	4.0	4.0
	130	7.5	7.0	6.5	6.0	5.5	5.0	4.5	4.5	4.0	4.0	4.0
	140	7.0	6.5	6.0	6.0	5.5	5.0	4.5	4.5	4.0	4.0	4.0
	150	6.5	6.0	6.0	5.5	5.0	5.0	4.5	4.5	4.0	4.0	4.0
	160	6.0	6.0	6.0	5.5	5.0	4.5	4.5	4.0	4.0	4.0	3.5
	170	5.5	5.5	5.5	5.0	5.0	4.5	4.5	4.0	4.0	4.0	3.5
	180	5.5	5.5	5.5	5.0	4.5	4.5	4.0	4.0	4.0	3.5	3.5
200	4.0	4.0	4.0	4.0	4.0	4.0	4.0	4.0	4.0	3.5	3.5	

NOTE: For rails that are continuous over less than 5 modules, reduce the listed max rail span by 1 ft.

Slope 27° - 45°

Max Spans (ft)												
Zone 2*	Wind Speed (mph)	Ground Snow Load (psf)										
Exposure		0	10	20	30	40	50	60	70	80	90	100
Exp B	100	9.0	9.0	7.5	6.5	6.0	5.5	5.0	4.5	4.5	4.5	4.0
	110	9.0	8.5	7.5	6.5	6.0	5.5	5.0	4.5	4.5	4.5	4.0
	115	8.5	8.0	7.5	6.5	6.0	5.5	5.0	4.5	4.5	4.0	4.0
	120	8.0	7.5	7.0	6.5	6.0	5.5	5.0	4.5	4.5	4.0	4.0
	130	7.5	7.0	7.0	6.0	6.0	5.5	5.0	4.5	4.5	4.0	4.0
	140	7.0	6.5	6.5	6.0	6.0	5.0	5.0	4.5	4.5	4.0	4.0
	150	6.5	6.5	6.5	6.0	5.5	5.0	4.5	4.5	4.5	4.0	4.0
	160	6.0	6.0	6.0	6.0	5.5	5.0	4.5	4.5	4.0	4.0	4.0
	170	5.5	5.5	5.5	5.5	5.0	5.0	4.5	4.5	4.0	4.0	4.0
	180	5.0	5.0	5.0	5.0	5.0	4.5	4.5	4.5	4.0	4.0	3.5
200	4.0	4.0	4.0	4.0	4.0	4.0	4.0	4.0	4.0	4.0	3.5	

Max Spans (ft)												
Zone 2*	Wind Speed (mph)	Ground Snow Load (psf)										
Exposure		0	10	20	30	40	50	60	70	80	90	100
Exp C	100	8.5	8.0	7.0	6.0	6.0	5.5	5.0	4.5	4.5	4.0	4.0
	110	8.0	7.5	7.0	6.0	6.0	5.5	5.0	4.5	4.5	4.0	4.0
	115	7.5	7.0	7.0	6.0	6.0	5.0	5.0	4.5	4.5	4.0	4.0
	120	7.5	7.0	6.5	6.0	5.5	5.0	5.0	4.5	4.5	4.0	4.0
	130	6.5	6.5	6.5	6.0	5.5	5.0	4.5	4.5	4.0	4.0	4.0
	140	6.0	6.0	6.0	6.0	5.5	5.0	4.5	4.5	4.0	4.0	4.0
	150	5.5	5.5	5.5	5.5	5.0	5.0	4.5	4.5	4.0	4.0	4.0
	160	5.5	5.5	5.5	5.5	5.0	4.5	4.5	4.0	4.0	4.0	3.5
	170	5.0	5.0	5.0	5.0	5.0	4.5	4.5	4.0	4.0	4.0	3.5
	180	4.5	4.5	4.5	4.5	4.5	4.5	4.0	4.0	4.0	3.5	3.5
200	3.5	3.5	3.5	3.5	3.5	3.5	3.5	3.5	3.5	3.5	3.5	

*Zone 2 includes all zone designations (including 2e, 2n, 2r).

NOTE: For rails that are continuous over less than 5 modules, reduce the listed max rail span by 1 ft.

Slope 27° - 45°

Max Spans (ft)												
Zone 3**	Wind Speed (mph)	Ground Snow Load (psf)										
Exposure		0	10	20	30	40	50	60	70	80	90	100
Exp B	100	9.0	8.5	7.5	6.5	6.0	5.5	5.0	4.5	4.5	4.5	4.0
	110	8.5	8.0	7.5	6.5	6.0	5.5	5.0	4.5	4.5	4.5	4.0
	115	8.0	7.5	7.5	6.5	6.0	5.5	5.0	4.5	4.5	4.0	4.0
	120	7.5	7.0	7.0	6.5	6.0	5.5	5.0	4.5	4.5	4.0	4.0
	130	7.0	6.5	6.5	6.0	6.0	5.5	5.0	4.5	4.5	4.0	4.0
	140	6.5	6.5	7.0	6.0	6.0	5.0	5.0	4.5	4.5	4.0	4.0
	150	6.5	6.5	6.0	6.0	5.5	5.0	4.5	4.5	4.5	4.0	4.0
	160	6.5	6.5	6.0	6.0	5.5	5.0	4.5	4.5	4.0	4.0	4.0
	170	5.5	5.5	5.5	5.5	5.0	5.0	4.5	4.5	4.0	4.0	4.0
	180	5.0	5.0	5.0	5.0	5.0	4.5	4.5	4.5	4.0	4.0	3.5
200	4.0	4.0	4.0	4.0	4.0	4.0	4.0	4.0	4.0	4.0	3.5	

Max Spans (ft)												
Zone 3**	Wind Speed (mph)	Ground Snow Load (psf)										
Exposure		0	10	20	30	40	50	60	70	80	90	100
Exp C	100	7.5	7.0	6.5	6.0	6.0	5.5	5.0	4.5	4.5	4.0	4.0
	110	7.0	7.0	6.5	6.0	6.0	5.5	5.0	4.5	4.5	4.0	4.0
	115	6.5	6.5	6.5	6.0	6.0	5.0	5.0	4.5	4.5	4.0	4.0
	120	6.0	6.0	6.0	6.0	5.5	5.0	5.0	4.5	4.5	4.0	4.0
	130	5.5	5.5	5.5	5.5	5.5	5.0	4.5	4.5	4.0	4.0	4.0
	140	5.0	5.0	5.0	5.0	5.0	5.0	4.5	4.5	4.0	4.0	4.0
	150	4.5	4.5	4.5	4.5	4.5	4.5	4.5	4.5	4.0	4.0	4.0
	160	4.5	4.5	4.5	4.5	4.5	4.5	4.5	4.0	4.0	4.0	3.5
	170	4.5	4.5	4.5	4.5	4.5	4.5	4.5	4.0	4.0	4.0	3.5
	180	4.0	4.0	4.0	4.0	4.0	4.0	4.0	4.0	4.0	3.5	3.5
200	3.0	3.0	3.0	3.0	3.0	3.0	3.0	3.0	3.0	3.0	3.0	

**Zone 3 includes all zone designations (including 3, 3e & 3r).

NOTE: For rails that are continuous over less than 5 modules, reduce the listed max rail span by 1 ft.

Slope 0° -7°

Max Spans (ft)												
Zone 1'	Wind Speed (mph)	Ground Snow Load (psf)										
Exposure		0	10	20	30	40	50	60	70	80	90	100
Exp B	100	8.5	8.0	6.0	5.0	4.0	4.0	3.5	3.0	3.0	3.0	2.5
	110	8.0	8.0	6.0	5.0	4.0	4.0	3.5	3.0	3.0	3.0	2.5
	115	7.5	7.5	6.0	5.0	4.0	4.0	3.5	3.0	3.0	3.0	2.5
	120	7.5	7.5	6.0	5.0	4.0	4.0	3.5	3.0	3.0	3.0	2.5
	130	6.5	6.5	6.0	5.0	4.0	4.0	3.5	3.0	3.0	3.0	2.5
	140	6.0	6.0	6.0	5.0	4.0	4.0	3.5	3.0	3.0	3.0	2.5
	150	6.0	6.0	6.0	5.0	4.0	4.0	3.5	3.0	3.0	3.0	2.5
	160	5.5	5.5	5.5	5.0	4.0	4.0	3.5	3.0	3.0	3.0	2.5
	170	5.0	5.0	5.0	5.0	4.0	4.0	3.5	3.0	3.0	3.0	2.5
	180	4.5	4.5	4.5	4.5	4.0	4.0	3.5	3.0	3.0	3.0	2.5
200	3.5	3.5	3.5	3.5	3.5	3.5	3.5	3.5	3.0	3.0	3.0	2.5

Max Spans (ft)												
Zone 1'	Wind Speed (mph)	Ground Snow Load (psf)										
Exposure		0	10	20	30	40	50	60	70	80	90	100
Exp C	100	7.0	7.0	6.0	5.0	4.0	4.0	3.5	3.0	3.0	3.0	2.5
	110	6.5	6.5	6.0	5.0	4.0	4.0	3.5	3.0	3.0	3.0	2.5
	115	6.5	6.5	6.0	5.0	4.0	4.0	3.5	3.0	3.0	3.0	2.5
	120	6.0	6.0	6.0	5.0	4.0	4.0	3.5	3.0	3.0	3.0	2.5
	130	6.0	6.0	6.0	5.0	4.0	4.0	3.5	3.0	3.0	3.0	2.5
	140	5.0	5.0	5.0	5.0	4.0	4.0	3.5	3.0	3.0	3.0	2.5
	150	5.0	5.0	5.0	5.0	4.0	4.0	3.5	3.0	3.0	3.0	2.5
	160	4.5	4.5	4.5	4.5	4.0	4.0	3.5	3.0	3.0	3.0	2.5
	170	4.0	4.0	4.0	4.0	4.0	4.0	3.5	3.0	3.0	3.0	2.5
	180	4.0	4.0	4.0	4.0	4.0	4.0	3.5	3.0	3.0	3.0	2.5
200	2.5	2.5	2.5	2.5	2.5	2.5	2.5	2.5	2.5	2.5	2.5	2.5

NOTE: For rails that are continuous over less than 5 modules, reduce the listed max rail span by 1 ft.

Slope 0° -7°

Max Spans (ft)												
Zone 1 & 2	Wind Speed (mph)	Ground Snow Load (psf)										
Exposure		0	10	20	30	40	50	60	70	80	90	100
Exp B	100	6.0	6.0	5.5	5.0	4.0	4.0	3.5	3.0	3.0	3.0	2.5
	110	5.5	5.5	5.5	5.0	4.0	4.0	3.5	3.0	3.0	3.0	2.5
	115	5.5	5.5	5.5	5.0	4.0	4.0	3.5	3.0	3.0	3.0	2.5
	120	5.0	5.0	5.0	5.0	4.0	4.0	3.5	3.0	3.0	3.0	2.5
	130	4.5	4.5	4.5	4.5	4.0	4.0	3.5	3.0	3.0	3.0	2.5
	140	4.0	4.0	4.0	4.0	4.0	4.0	3.5	3.0	3.0	3.0	2.5
	150	4.0	4.0	4.0	4.0	4.0	4.0	3.5	3.0	3.0	3.0	2.5
	160	3.5	3.5	3.5	3.5	3.5	3.5	3.5	3.0	3.0	3.0	2.5
	170	3.5	3.5	3.5	3.5	3.5	3.5	3.5	3.0	3.0	3.0	2.5
	180	3.0	3.0	3.0	3.0	3.0	3.0	3.0	3.0	3.0	3.0	2.5
200	2.0	2.0	2.0	2.0	2.0	2.0	2.0	2.0	2.0	2.0	2.0	

Max Spans (ft)												
Zone 1 & 2	Wind Speed (mph)	Ground Snow Load (psf)										
Exposure		0	10	20	30	40	50	60	70	80	90	100
Exp C	100	5.0	5.0	5.0	5.0	4.0	4.0	3.5	3.0	3.0	3.0	2.5
	110	4.5	4.5	4.5	4.5	4.0	4.0	3.5	3.0	3.0	3.0	2.5
	115	4.5	4.5	4.5	4.5	4.0	4.0	3.5	3.0	3.0	3.0	2.5
	120	4.0	4.0	4.0	4.0	4.0	4.0	3.5	3.0	3.0	3.0	2.5
	130	3.5	3.5	3.5	3.5	3.5	3.5	3.5	3.0	3.0	3.0	2.5
	140	3.5	3.5	3.5	3.5	3.5	3.5	3.5	3.0	3.0	3.0	2.5
	150	3.0	3.0	3.0	3.0	3.0	3.0	3.0	3.0	3.0	3.0	2.5
	160	3.0	3.0	3.0	3.0	3.0	3.0	3.0	3.0	3.0	3.0	2.5
	170	2.5	2.5	2.5	2.5	2.5	2.5	2.5	2.5	2.5	2.5	2.5
	180	2.5	2.5	2.5	2.5	2.5	2.5	2.5	2.5	2.5	2.5	2.5
200	2.0	2.0	2.0	2.0	2.0	2.0	2.0	2.0	2.0	2.0	2.0	

NOTE: For rails that are continuous over less than 5 modules, reduce the listed max rail span by 1 ft.

Slope 0° -7°

Max Spans (ft)												
Zone 3	Wind Speed (mph)	Ground Snow Load (psf)										
Exposure		0	10	20	30	40	50	60	70	80	90	100
Exp B	100	5.5	5.5	5.0	5.0	4.0	4.0	3.5	3.0	3.0	3.0	2.5
	110	5.0	5.0	5.0	5.0	4.0	4.0	3.5	3.0	3.0	3.0	2.5
	115	4.5	4.5	4.5	4.5	4.0	4.0	3.5	3.0	3.0	3.0	2.5
	120	4.5	4.5	4.5	4.5	4.0	4.0	3.5	3.0	3.0	3.0	2.5
	130	4.0	4.0	4.0	4.0	4.0	4.0	3.5	3.0	3.0	3.0	2.5
	140	4.0	4.0	4.0	4.0	4.0	4.0	3.5	3.0	3.0	3.0	2.5
	150	3.5	3.5	3.5	3.5	3.5	3.5	3.5	3.0	3.0	3.0	2.5
	160	3.5	3.5	3.5	3.5	3.5	3.5	3.5	3.0	3.0	3.0	2.5
	170	3.0	3.0	3.0	3.0	3.0	3.0	3.0	3.0	3.0	3.0	2.5
	180	3.0	3.0	3.0	3.0	3.0	3.0	3.0	3.0	3.0	3.0	2.5
200	2.0	2.0	2.0	2.0	2.0	2.0	2.0	2.0	2.0	2.0	2.0	

Max Spans (ft)												
Zone 3	Wind Speed (mph)	Ground Snow Load (psf)										
Exposure		0	10	20	30	40	50	60	70	80	90	100
Exp C	100	4.5	4.5	4.0	4.0	4.0	4.0	3.5	3.0	3.0	3.0	2.5
	110	4.0	4.0	4.0	4.0	4.0	4.0	3.5	3.0	3.0	3.0	2.5
	115	4.0	4.0	4.0	4.0	4.0	4.0	3.5	3.0	3.0	3.0	2.5
	120	3.5	3.5	3.5	3.5	3.5	3.5	3.5	3.0	3.0	3.0	2.5
	130	3.5	3.5	3.5	3.5	3.5	3.5	3.5	3.0	3.0	3.0	2.5
	140	3.0	3.0	3.0	3.0	3.0	3.0	3.0	3.0	3.0	3.0	2.5
	150	3.0	3.0	3.0	3.0	3.0	3.0	3.0	3.0	3.0	3.0	2.5
	160	2.5	2.5	2.5	2.5	2.5	2.5	2.5	2.5	2.5	2.5	2.5
	170	2.5	2.5	2.5	2.5	2.5	2.5	2.5	2.5	2.5	2.5	2.5
	180	2.5	2.5	2.5	2.5	2.5	2.5	2.5	2.5	2.5	2.5	2.5
200	2.0	2.0	2.0	2.0	2.0	2.0	2.0	2.0	2.0	2.0	2.0	

NOTE: For rails that are continuous over less than 5 modules, reduce the listed max rail span by 1 ft.

Slope 7° - 20°

Max Spans (ft)												
Zone 1	Wind Speed (mph)	Ground Snow Load (psf)										
Exposure		0	10	20	30	40	50	60	70	80	90	100
Exp B	100	7.5	7.0	6.0	5.0	4.0	4.0	3.5	3.0	3.0	3.0	2.5
	110	7.0	7.0	6.0	5.0	4.0	4.0	3.5	3.0	3.0	3.0	2.5
	115	6.5	6.5	6.0	5.0	4.0	4.0	3.5	3.0	3.0	3.0	2.5
	120	6.0	6.0	5.5	5.0	4.0	4.0	3.5	3.0	3.0	3.0	2.5
	130	5.5	5.5	5.5	5.0	4.0	4.0	3.5	3.0	3.0	3.0	2.5
	140	5.0	5.0	5.0	5.0	4.0	4.0	3.5	3.0	3.0	3.0	2.5
	150	4.5	4.5	4.5	4.5	4.0	4.0	3.5	3.0	3.0	3.0	2.5
	160	4.5	4.5	4.5	4.5	4.0	4.0	3.5	3.0	3.0	3.0	2.5
	170	4.5	4.5	4.5	4.5	4.0	4.0	3.5	3.0	3.0	3.0	2.5
	180	4.0	4.0	4.0	4.0	4.0	4.0	3.5	3.0	3.0	3.0	2.5
200	3.0	3.0	3.0	3.0	3.0	3.0	3.0	3.0	3.0	3.0	2.5	

Max Spans (ft)												
Zone 1	Wind Speed (mph)	Ground Snow Load (psf)										
Exposure		0	10	20	30	40	50	60	70	80	90	100
Exp C	100	6.5	6.5	5.5	5.0	4.0	4.0	3.5	3.0	3.0	3.0	2.5
	110	6.0	6.0	5.5	5.0	4.0	4.0	3.5	3.0	3.0	3.0	2.5
	115	5.5	5.5	5.5	5.0	4.0	4.0	3.5	3.0	3.0	3.0	2.5
	120	5.0	5.0	5.0	5.0	4.0	4.0	3.5	3.0	3.0	3.0	2.5
	130	4.5	4.5	4.5	4.5	4.0	4.0	3.5	3.0	3.0	3.0	2.5
	140	4.0	4.0	4.0	4.0	4.0	4.0	3.5	3.0	3.0	3.0	2.5
	150	4.0	4.0	4.0	4.0	4.0	4.0	3.5	3.0	3.0	3.0	2.5
	160	3.5	3.5	3.5	3.5	3.5	3.5	3.5	3.0	3.0	3.0	2.5
	170	3.5	3.5	3.5	3.5	3.5	3.5	3.5	3.0	3.0	3.0	2.5
	180	3.0	3.0	3.0	3.0	3.0	3.0	3.0	3.0	3.0	3.0	2.5
200	2.5	2.5	2.5	2.5	2.5	2.5	2.5	2.5	2.5	2.5	2.5	

NOTE: For rails that are continuous over less than 5 modules, reduce the listed max rail span by 1 ft.

Slope 7° - 20°

Max Spans (ft)												
Zone 2*	Wind Speed (mph)	Ground Snow Load (psf)										
Exposure		0	10	20	30	40	50	60	70	80	90	100
Exp B	100	6.0	6.0	5.5	5.0	4.0	4.0	3.5	3.0	3.0	3.0	2.5
	110	5.5	5.5	5.5	5.0	4.0	4.0	3.5	3.0	3.0	3.0	2.5
	115	5.5	5.5	5.5	5.0	4.0	4.0	3.5	3.0	3.0	3.0	2.5
	120	5.0	5.0	5.0	5.0	4.0	4.0	3.5	3.0	3.0	3.0	2.5
	130	4.5	4.5	4.5	4.5	4.0	4.0	3.5	3.0	3.0	3.0	2.5
	140	4.0	4.0	4.0	4.0	4.0	4.0	3.5	3.0	3.0	3.0	2.5
	150	4.0	4.0	4.0	4.0	4.0	4.0	3.5	3.0	3.0	3.0	2.5
	160	3.5	3.5	3.5	3.5	3.5	3.5	3.5	3.0	3.0	3.0	2.5
	170	3.5	3.5	3.5	3.5	3.5	3.5	3.5	3.0	3.0	3.0	2.5
	180	3.0	3.0	3.0	3.0	3.0	3.0	3.0	3.0	3.0	3.0	2.5
200	2.5	2.5	2.5	2.5	2.5	2.5	2.5	2.5	2.5	2.5	2.5	

Max Spans (ft)												
Zone 2*	Wind Speed (mph)	Ground Snow Load (psf)										
Exposure		0	10	20	30	40	50	60	70	80	90	100
Exp C	100	5.0	5.0	5.0	4.5	4.0	4.0	3.5	3.0	3.0	3.0	2.5
	110	4.5	4.5	4.5	4.5	4.0	4.0	3.5	3.0	3.0	3.0	2.5
	115	4.5	4.5	4.5	4.5	4.0	4.0	3.5	3.0	3.0	3.0	2.5
	120	4.0	4.0	4.0	4.0	4.0	4.0	3.5	3.0	3.0	3.0	2.5
	130	4.0	4.0	4.0	4.0	4.0	4.0	3.5	3.0	3.0	3.0	2.5
	140	3.5	3.5	3.5	3.5	3.5	3.5	3.5	3.0	3.0	3.0	2.5
	150	3.0	3.0	3.0	3.0	3.0	3.0	3.0	3.0	3.0	3.0	2.5
	160	3.0	3.0	3.0	3.0	3.0	3.0	3.0	3.0	3.0	3.0	2.5
	170	2.5	2.5	2.5	2.5	2.5	2.5	2.5	2.5	2.5	2.5	2.5
	180	2.5	2.5	2.5	2.5	2.5	2.5	2.5	2.5	2.5	2.5	2.5
200	2.0	2.0	2.0	2.0	2.0	2.0	2.0	2.0	2.0	2.0	2.0	

*Zone 2 includes all zone designations (including 2e, 2n, 2r).

Slope 7° - 20°

Max Spans (ft)												
Zone 3**	Wind Speed (mph)	Ground Snow Load (psf)										
Exposure		0	10	20	30	40	50	60	70	80	90	100
Exp B	100	5.5	5.5	5.0	5.0	4.0	4.0	3.5	3.0	3.0	3.0	2.5
	110	5.0	5.0	5.0	5.0	4.0	4.0	3.5	3.0	3.0	3.0	2.5
	115	4.5	4.5	4.5	4.5	4.0	4.0	3.5	3.0	3.0	3.0	2.5
	120	4.5	4.5	4.5	4.5	4.0	4.0	3.5	3.0	3.0	3.0	2.5
	130	4.0	4.0	4.0	4.0	4.0	4.0	3.5	3.0	3.0	3.0	2.5
	140	4.0	4.0	4.0	4.0	4.0	4.0	3.5	3.0	3.0	3.0	2.5
	150	3.5	3.5	3.5	3.5	3.5	3.5	3.5	3.0	3.0	3.0	2.5
	160	3.0	3.0	3.0	3.0	3.0	3.0	3.0	3.0	3.0	3.0	2.5
	170	3.0	3.0	3.0	3.0	3.0	3.0	3.0	3.0	3.0	3.0	2.5
	180	3.0	3.0	3.0	3.0	3.0	3.0	3.0	3.0	3.0	3.0	2.5
	200	2.0	2.0	2.0	2.0	2.0	2.0	2.0	2.0	2.0	2.0	2.0

Max Spans (ft)												
Zone 3**	Wind Speed (mph)	Ground Snow Load (psf)										
Exposure		0	10	20	30	40	50	60	70	80	90	100
Exp C	100	4.5	4.5	4.0	4.0	4.0	4.0	3.5	3.0	3.0	3.0	2.5
	110	4.0	4.0	4.0	4.0	4.0	4.0	3.5	3.0	3.0	3.0	2.5
	115	4.0	4.0	4.0	4.0	4.0	4.0	3.5	3.0	3.0	3.0	2.5
	120	3.5	3.5	3.5	3.5	3.5	3.5	3.5	3.0	3.0	3.0	2.5
	130	3.5	3.5	3.5	3.5	3.5	3.5	3.5	3.0	3.0	3.0	2.5
	140	3.0	3.0	3.0	3.0	3.0	3.0	3.0	3.0	3.0	3.0	2.5
	150	3.0	3.0	3.0	3.0	3.0	3.0	3.0	3.0	3.0	3.0	2.5
	160	2.5	2.5	2.5	2.5	2.5	2.5	2.5	2.5	2.5	2.5	2.5
	170	2.5	2.5	2.5	2.5	2.5	2.5	2.5	2.5	2.5	2.5	2.5
	180	2.5	2.5	2.5	2.5	2.5	2.5	2.5	2.5	2.5	2.5	2.5
	200	2.0	2.0	2.0	2.0	2.0	2.0	2.0	2.0	2.0	2.0	2.0

**Zone 3 includes all zone designations (including 3, 3e & 3r).

NOTE: For rails that are continuous over less than 5 modules, reduce the listed max rail span by 1 ft.

Slope 20° - 27°

Max Spans (ft)												
Zone 1	Wind Speed (mph)	Ground Snow Load (psf)										
Exposure		0	10	20	30	40	50	60	70	80	90	100
Exp B	100	7.5	7.5	6.0	5.0	4.0	4.0	3.5	3.0	3.0	3.0	2.5
	110	7.0	7.0	6.0	5.0	4.0	4.0	3.5	3.0	3.0	3.0	2.5
	115	6.5	6.5	6.0	5.0	4.0	4.0	3.5	3.0	3.0	3.0	2.5
	120	6.0	6.0	5.5	5.0	4.0	4.0	3.5	3.0	3.0	3.0	2.5
	130	5.5	5.5	5.5	5.0	4.0	4.0	3.5	3.0	3.0	3.0	2.5
	140	5.5	5.5	5.5	5.0	4.0	4.0	3.5	3.0	3.0	3.0	2.5
	150	5.0	5.0	5.0	5.0	4.0	4.0	3.5	3.0	3.0	3.0	2.5
	160	5.0	5.0	5.0	5.0	4.0	4.0	3.5	3.0	3.0	3.0	2.5
	170	4.5	4.5	4.5	4.5	4.0	4.0	3.5	3.0	3.0	3.0	2.5
	180	4.0	4.0	4.0	4.0	4.0	4.0	3.5	3.0	3.0	3.0	2.5
200	3.0	3.0	3.0	3.0	3.0	3.0	3.0	3.0	3.0	3.0	2.5	

Max Spans (ft)												
Zone 1	Wind Speed (mph)	Ground Snow Load (psf)										
Exposure		0	10	20	30	40	50	60	70	80	90	100
Exp C	100	6.0	6.0	5.5	5.0	4.0	4.0	3.5	3.0	3.0	3.0	2.5
	110	5.5	5.5	5.5	5.0	4.0	4.0	3.5	3.0	3.0	3.0	2.5
	115	5.5	5.5	5.5	5.0	4.0	4.0	3.5	3.0	3.0	3.0	2.5
	120	5.0	5.0	5.0	5.0	4.0	4.0	3.5	3.0	3.0	3.0	2.5
	130	5.0	5.0	5.0	5.0	4.0	4.0	3.5	3.0	3.0	3.0	2.5
	140	4.5	4.5	4.5	4.5	4.0	4.0	3.5	3.0	3.0	3.0	2.5
	150	4.0	4.0	4.0	4.0	4.0	4.0	3.5	3.0	3.0	3.0	2.5
	160	3.5	3.5	3.5	3.5	3.5	3.5	3.5	3.0	3.0	3.0	2.5
	170	3.5	3.5	3.5	3.5	3.5	3.5	3.5	3.0	3.0	3.0	2.5
	180	3.0	3.0	3.0	3.0	3.0	3.0	3.0	3.0	3.0	3.0	2.5
200	2.5	2.5	2.5	2.5	2.5	2.5	2.5	2.5	2.5	2.5	2.5	

NOTE: For rails that are continuous over less than 5 modules, reduce the listed max rail span by 1 ft.

Slope 20° - 27°

Max Spans (ft)												
Zone 2*	Wind Speed (mph)	Ground Snow Load (psf)										
Exposure		0	10	20	30	40	50	60	70	80	90	100
Exp B	100	6.0	6.0	5.5	5.0	4.0	4.0	3.5	3.0	3.0	3.0	2.5
	110	5.5	5.5	5.5	5.0	4.0	4.0	3.5	3.0	3.0	3.0	2.5
	115	5.0	5.0	5.0	5.0	4.0	4.0	3.5	3.0	3.0	3.0	2.5
	120	4.5	4.5	4.5	4.5	4.0	4.0	3.5	3.0	3.0	3.0	2.5
	130	4.0	4.0	4.0	4.0	4.0	4.0	3.5	3.0	3.0	3.0	2.5
	140	4.0	4.0	4.0	4.0	4.0	4.0	3.5	3.0	3.0	3.0	2.5
	150	4.0	4.0	4.0	4.0	4.0	4.0	3.5	3.0	3.0	3.0	2.5
	160	3.5	3.5	3.5	3.5	3.5	3.5	3.5	3.0	3.0	3.0	2.5
	170	3.5	3.5	3.5	3.5	3.5	3.5	3.5	3.0	3.0	3.0	2.5
	180	3.0	3.0	3.0	3.0	3.0	3.0	3.0	3.0	3.0	3.0	2.5
200	2.0	2.0	2.0	2.0	2.0	2.0	2.0	2.0	2.0	2.0	2.0	

Max Spans (ft)												
Zone 2*	Wind Speed (mph)	Ground Snow Load (psf)										
Exposure		0	10	20	30	40	50	60	70	80	90	100
Exp C	100	4.5	4.5	4.5	4.0	4.0	4.0	3.5	3.0	3.0	3.0	2.5
	110	4.0	4.0	4.0	4.0	4.0	4.0	3.5	3.0	3.0	3.0	2.5
	115	4.0	4.0	4.0	4.0	4.0	4.0	3.5	3.0	3.0	3.0	2.5
	120	3.5	3.5	3.5	3.5	3.5	3.5	3.5	3.0	3.0	3.0	2.5
	130	3.5	3.5	3.5	3.5	3.5	3.5	3.5	3.0	3.0	3.0	2.5
	140	3.5	3.5	3.5	3.5	3.5	3.5	3.5	3.0	3.0	3.0	2.5
	150	3.0	3.0	3.0	3.0	3.0	3.0	3.0	3.0	3.0	3.0	2.5
	160	3.0	3.0	3.0	3.0	3.0	3.0	3.0	3.0	3.0	3.0	2.5
	170	2.5	2.5	2.5	2.5	2.5	2.5	2.5	2.5	2.5	2.5	2.5
	180	2.5	2.5	2.5	2.5	2.5	2.5	2.5	2.5	2.5	2.5	2.5
200	2.0	2.0	2.0	2.0	2.0	2.0	2.0	2.0	2.0	2.0	2.0	

*Zone 2 includes all zone designations (including 2e, 2n, 2r).

NOTE: For rails that are continuous over less than 5 modules, reduce the listed max rail span by 1 ft.

Slope 20° - 27°

Max Spans (ft)												
Zone 3**	Wind Speed (mph)	Ground Snow Load (psf)										
Exposure		0	10	20	30	40	50	60	70	80	90	100
Exp B	100	5.5	5.5	5.0	5.0	4.0	4.0	3.5	3.0	3.0	3.0	2.5
	110	5.0	5.0	5.0	5.0	4.0	4.0	3.5	3.0	3.0	3.0	2.5
	115	4.5	4.5	4.5	4.5	4.0	4.0	3.5	3.0	3.0	3.0	2.5
	120	4.5	4.5	4.5	4.5	4.0	4.0	3.5	3.0	3.0	3.0	2.5
	130	4.0	4.0	4.0	4.0	4.0	4.0	3.5	3.0	3.0	3.0	2.5
	140	4.0	4.0	4.0	4.0	4.0	4.0	3.5	3.0	3.0	3.0	2.5
	150	3.5	3.5	3.5	3.5	3.5	3.5	3.5	3.0	3.0	3.0	2.5
	160	3.0	3.0	3.0	3.0	3.0	3.0	3.0	3.0	3.0	3.0	2.5
	170	3.0	3.0	3.0	3.0	3.0	3.0	3.0	3.0	3.0	3.0	2.5
	180	3.0	3.0	3.0	3.0	3.0	3.0	3.0	3.0	3.0	3.0	2.5
	200	2.0	2.0	2.0	2.0	2.0	2.0	2.0	2.0	2.0	2.0	2.0

Max Spans (ft)												
Zone 3**	Wind Speed (mph)	Ground Snow Load (psf)										
Exposure		0	10	20	30	40	50	60	70	80	90	100
Exp C	100	4.5	4.5	4.5	4.0	4.0	4.0	3.5	3.0	3.0	3.0	2.5
	110	4.0	4.0	4.0	4.0	4.0	4.0	3.5	3.0	3.0	3.0	2.5
	115	4.0	4.0	4.0	4.0	4.0	4.0	3.5	3.0	3.0	3.0	2.5
	120	3.5	3.5	3.5	3.5	3.5	3.5	3.5	3.0	3.0	3.0	2.5
	130	3.5	3.5	3.5	3.5	3.5	3.5	3.5	3.0	3.0	3.0	2.5
	140	3.0	3.0	3.0	3.0	3.0	3.0	3.0	3.0	3.0	3.0	2.5
	150	3.0	3.0	3.0	3.0	3.0	3.0	3.0	3.0	3.0	3.0	2.5
	160	2.5	2.5	2.5	2.5	2.5	2.5	2.5	2.5	2.5	2.5	2.5
	170	2.5	2.5	2.5	2.5	2.5	2.5	2.5	2.5	2.5	2.5	2.5
	180	2.5	2.5	2.5	2.5	2.5	2.5	2.5	2.5	2.5	2.5	2.5
	200	2.0	2.0	2.0	2.0	2.0	2.0	2.0	2.0	2.0	2.0	2.0

**Zone 3 includes all zone designations (including 3, 3e & 3r).

NOTE: For rails that are continuous over less than 5 modules, reduce the listed max rail span by 1 ft.

Slope 27° - 45°

Max Spans (ft)												
Zone 1	Wind Speed (mph)	Ground Snow Load (psf)										
Exposure		0	10	20	30	40	50	60	70	80	90	100
Exp B	100	8.0	7.0	6.0	5.5	5.0	4.5	4.0	3.5	3.5	3.0	3.0
	110	7.5	6.5	6.0	5.5	5.0	4.5	4.0	3.5	3.5	3.0	3.0
	115	7.0	6.5	6.0	5.5	5.0	4.5	4.0	3.5	3.5	3.0	3.0
	120	7.0	6.0	6.0	5.5	5.0	4.5	4.0	3.5	3.5	3.0	3.0
	130	6.5	6.0	5.5	5.5	5.0	4.5	4.0	3.5	3.5	3.0	3.0
	140	5.5	5.5	5.5	5.0	5.0	4.5	4.0	3.5	3.5	3.0	3.0
	150	5.5	5.5	5.5	5.0	4.5	4.5	4.0	3.5	3.5	3.0	3.0
	160	5.0	5.0	5.0	4.5	4.5	4.0	4.0	3.5	3.5	3.0	3.0
	170	4.5	4.5	4.5	4.5	4.5	4.0	4.0	3.5	3.5	3.0	3.0
	180	4.5	4.5	4.5	4.5	4.0	4.0	4.0	3.5	3.5	3.0	3.0
200	3.0	3.0	3.0	3.0	3.0	3.0	3.0	3.0	3.0	3.0	3.0	

Max Spans (ft)												
Zone 1	Wind Speed (mph)	Ground Snow Load (psf)										
Exposure		0	10	20	30	40	50	60	70	80	90	100
Exp C	100	7.0	6.5	6.0	5.5	5.0	4.5	4.0	3.5	3.5	3.0	3.0
	110	6.5	6.0	6.0	5.5	5.0	4.5	4.0	3.5	3.5	3.0	3.0
	115	6.0	5.5	5.5	5.0	5.0	4.5	4.0	3.5	3.5	3.0	3.0
	120	5.5	5.5	5.5	5.0	4.5	4.5	4.0	3.5	3.5	3.0	3.0
	130	5.5	5.5	5.0	5.0	4.5	4.5	4.0	3.5	3.5	3.0	3.0
	140	4.5	4.5	4.5	4.5	4.5	4.0	4.0	3.5	3.5	3.0	3.0
	150	4.5	4.5	4.5	4.5	4.0	4.0	4.0	3.5	3.5	3.0	3.0
	160	4.0	4.0	4.0	4.0	4.0	4.0	3.5	3.5	3.5	3.0	3.0
	170	3.5	3.5	3.5	3.5	3.5	3.5	3.5	3.5	3.5	3.0	3.0
	180	3.5	3.5	3.5	3.5	3.5	3.5	3.5	3.5	3.5	3.0	3.0
200	2.0	2.0	2.0	2.0	2.0	2.0	2.0	2.0	2.0	2.0	2.0	

NOTE: For rails that are continuous over less than 5 modules, reduce the listed max rail span by 1 ft.

Slope 27° - 45°

Max Spans (ft)												
Zone 2*	Wind Speed (mph)	Ground Snow Load (psf)										
Exposure		0	10	20	30	40	50	60	70	80	90	100
Exp B	100	7.0	6.5	6.0	5.5	5.0	4.5	4.0	3.5	3.5	3.0	3.0
	110	6.5	6.0	6.0	5.5	5.0	4.5	4.0	3.5	3.5	3.0	3.0
	115	6.0	6.0	6.0	5.5	5.0	4.5	4.0	3.5	3.5	3.0	3.0
	120	5.5	5.5	5.5	5.5	5.0	4.5	4.0	3.5	3.5	3.0	3.0
	130	5.0	5.0	5.0	5.0	5.0	4.5	4.0	3.5	3.5	3.0	3.0
	140	5.0	5.0	5.0	5.0	5.0	4.5	4.0	3.5	3.5	3.0	3.0
	150	4.5	4.5	4.5	4.5	4.5	4.5	4.0	3.5	3.5	3.0	3.0
	160	4.0	4.0	4.0	4.0	4.0	4.0	4.0	3.5	3.5	3.0	3.0
	170	3.5	3.5	3.5	3.5	3.5	3.5	3.5	3.5	3.5	3.0	3.0
	180	3.5	3.5	3.5	3.5	3.5	3.5	3.5	3.5	3.5	3.0	3.0
	200	2.5	2.5	2.5	2.5	2.5	2.5	2.5	2.5	2.5	2.5	2.5

Max Spans (ft)												
Zone 2*	Wind Speed (mph)	Ground Snow Load (psf)										
Exposure		0	10	20	30	40	50	60	70	80	90	100
Exp C	100	5.5	5.5	5.5	5.5	5.0	4.5	4.0	3.5	3.5	3.0	3.0
	110	5.0	5.0	5.0	5.5	5.0	4.5	4.0	3.5	3.5	3.0	3.0
	115	5.0	5.0	5.0	5.0	5.0	4.5	4.0	3.5	3.5	3.0	3.0
	120	4.5	4.5	4.5	4.5	4.5	4.5	4.0	3.5	3.5	3.0	3.0
	130	4.0	4.0	4.0	4.0	4.0	4.0	4.0	3.5	3.5	3.0	3.0
	140	3.5	3.5	3.5	3.5	3.5	3.5	3.5	3.5	3.5	3.0	3.0
	150	3.5	3.5	3.5	3.5	3.5	3.5	3.5	3.5	3.5	3.0	3.0
	160	3.0	3.0	3.0	3.0	3.0	3.0	3.0	3.0	3.0	3.0	3.0
	170	3.0	3.0	3.0	3.0	3.0	3.0	3.0	3.0	3.0	3.0	3.0
	180	3.0	3.0	3.0	3.0	3.0	3.0	3.0	3.0	3.0	3.0	3.0
	200	2.0	2.0	2.0	2.0	2.0	2.0	2.0	2.0	2.0	2.0	2.0

*Zone 2 includes all zone designations (including 2e, 2n, 2r).

Slope 27° - 45°

Max Spans (ft)												
Zone 3**	Wind Speed (mph)	Ground Snow Load (psf)										
Exposure		0	10	20	30	40	50	60	70	80	90	100
Exp B	100	6.5	6.0	5.5	5.5	5.0	4.5	4.0	3.5	3.5	3.0	3.0
	110	6.0	5.5	5.5	5.5	5.0	4.5	4.0	3.5	3.5	3.0	3.0
	115	5.5	5.5	5.5	5.5	5.0	4.5	4.0	3.5	3.5	3.0	3.0
	120	5.0	5.0	5.0	5.0	5.0	4.5	4.0	3.5	3.5	3.0	3.0
	130	4.5	4.5	4.5	4.5	4.5	4.5	4.0	3.5	3.5	3.0	3.0
	140	4.5	4.5	4.5	4.5	4.5	4.5	4.0	3.5	3.5	3.0	3.0
	150	4.0	4.0	4.0	4.0	4.0	4.0	4.0	3.5	3.5	3.0	3.0
	160	4.0	4.0	4.0	4.0	4.0	4.0	4.0	3.5	3.5	3.0	3.0
	170	3.5	3.5	3.5	3.5	3.5	3.5	3.5	3.5	3.5	3.0	3.0
	180	3.5	3.5	3.5	3.5	3.5	3.5	3.5	3.5	3.5	3.0	3.0
	200	2.5	2.5	2.5	2.5	2.5	2.5	2.5	2.5	2.5	2.5	2.5

Max Spans (ft)												
Zone 3**	Wind Speed (mph)	Ground Snow Load (psf)										
Exposure		0	10	20	30	40	50	60	70	80	90	100
Exp C	100	5.5	5.5	5.0	5.5	5.0	4.5	4.0	3.5	3.5	3.0	3.0
	110	5.0	5.0	5.0	5.5	5.0	4.5	4.0	3.5	3.5	3.0	3.0
	115	5.0	5.0	5.0	5.0	5.0	4.5	4.0	3.5	3.5	3.0	3.0
	120	4.5	4.5	4.5	4.5	4.5	4.5	4.0	3.5	3.5	3.0	3.0
	130	4.0	4.0	4.0	4.0	4.0	4.0	4.0	3.5	3.5	3.0	3.0
	140	3.5	3.5	3.5	3.5	3.5	3.5	3.5	3.5	3.5	3.0	3.0
	150	3.5	3.5	3.5	3.5	3.5	3.5	3.5	3.5	3.5	3.0	3.0
	160	3.0	3.0	3.0	3.0	3.0	3.0	3.0	3.0	3.0	3.0	3.0
	170	3.0	3.0	3.0	3.0	3.0	3.0	3.0	3.0	3.0	3.0	3.0
	180	3.0	3.0	3.0	3.0	3.0	3.0	3.0	3.0	3.0	3.0	3.0
	200	2.0	2.0	2.0	2.0	2.0	2.0	2.0	2.0	2.0	2.0	2.0

**Zone 3 includes all zone designations (including 3, 3e & 3r).

NOTE: For rails that are continuous over less than 5 modules, reduce the listed max rail span by 1 ft.

2.3 – Allowable Splice Locations

Rail Splices are to be located within a 1ft length at 25% of the span away from an exterior anchor or 2ft length at 25% of the span for interior anchor. (See figure below)

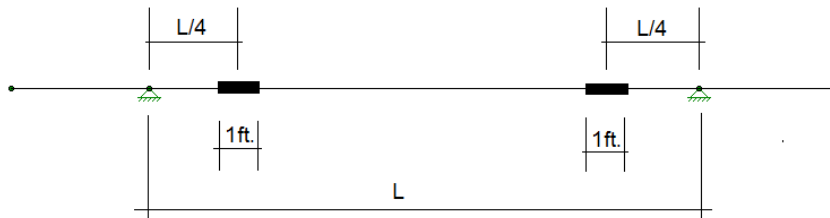

Single Span

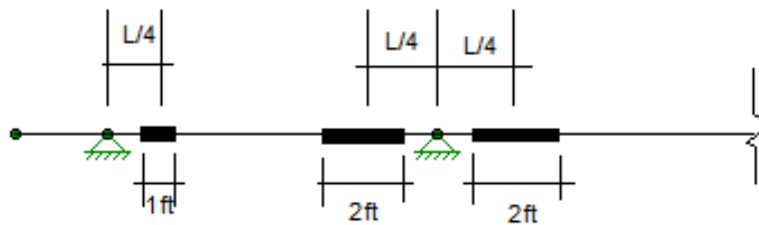

Continuous Span (3 spans or greater)

2.4 - Roof Zones

Wind forces are determined in accordance with ASCE 7-16 Section 29.4.4. In accordance with Figures 30.3-2A-I, the roof has been broken up into zones, 1, 2, & 3 (includes their sub-categories as noted in the summary tables). See Figures below (Figures referenced directly from ASCE 7-16).

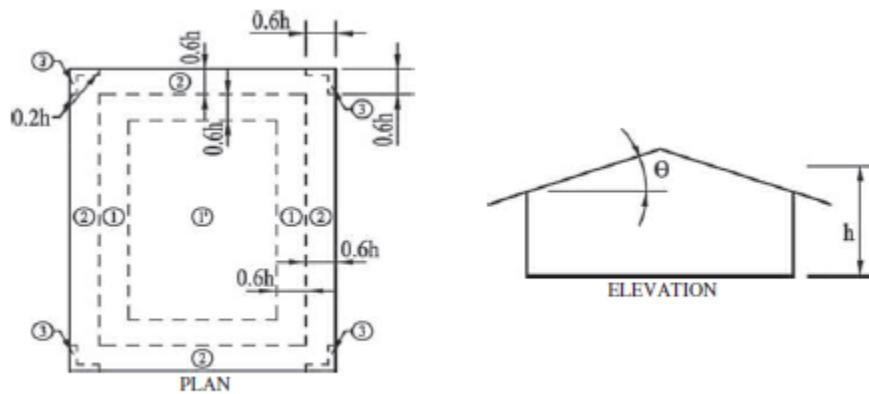

FIGURE 30.3-2A Components and Cladding [$h \leq 60$ ft ($h \leq 18.3$ m)]: External Pressure Coefficients, ($G C_p$), for Enclosed and Partially Enclosed Buildings—Gable Roofs, $\theta \leq 7^\circ$

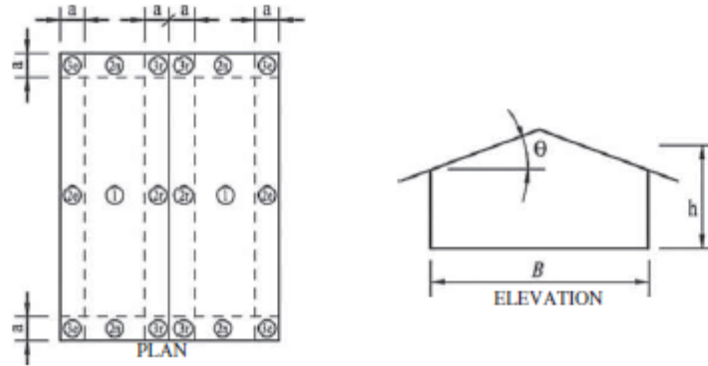

FIGURE 30.3-2B Components and Cladding [$h \leq 60$ ft ($h \leq 18.3$ m)]: External Pressure Coefficients, (GC_p), for Enclosed and Partially Enclosed Buildings—Gable Roofs, $7^\circ < \theta \leq 20^\circ$

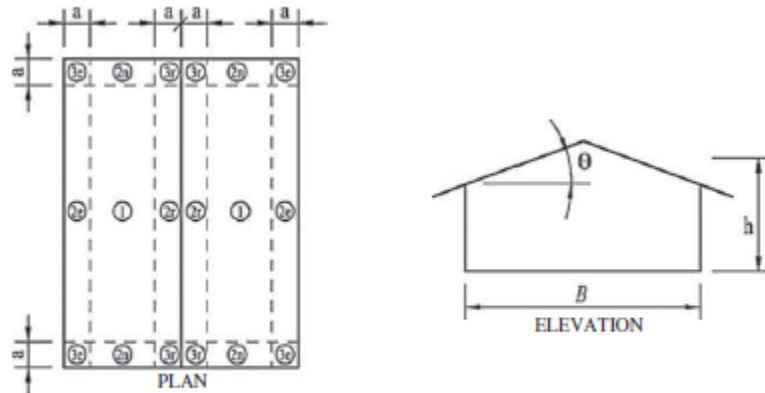

FIGURE 30.3-2C Components and Cladding [$h \leq 60$ ft ($h \leq 18.3$ m)]: External Pressure Coefficients, (GC_p), for Enclosed and Partially Enclosed Buildings—Gable Roofs, $20^\circ < \theta \leq 27^\circ$

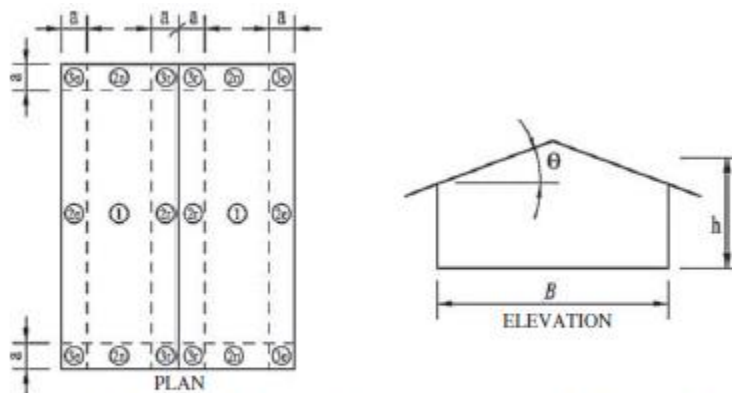

FIGURE 30.3-2D Components and Cladding [$h \leq 60$ ft ($h \leq 18.3$ m)]: External Pressure Coefficients, (GC_p), for Enclosed and Partially Enclosed Buildings—Gable Roofs, $27^\circ < \theta \leq 45^\circ$

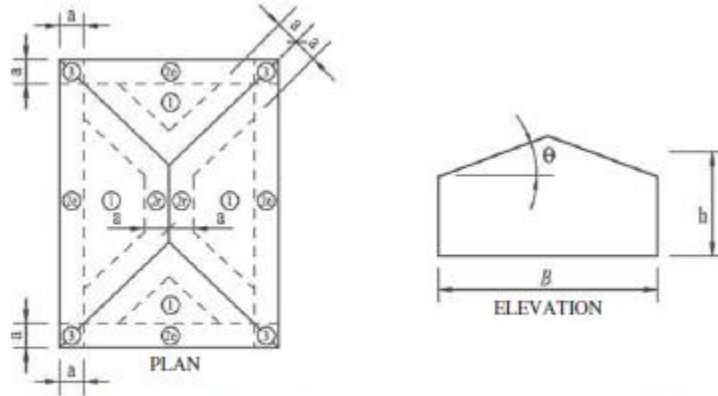

FIGURE 30.3-2E Components and Cladding [$h \leq 60$ ft ($h \leq 18.3$ m)]: External Pressure Coefficients, (GC_p), for Enclosed and Partially Enclosed Buildings—Hip Roofs, $7^\circ < \theta \leq 20^\circ$ (Roof)

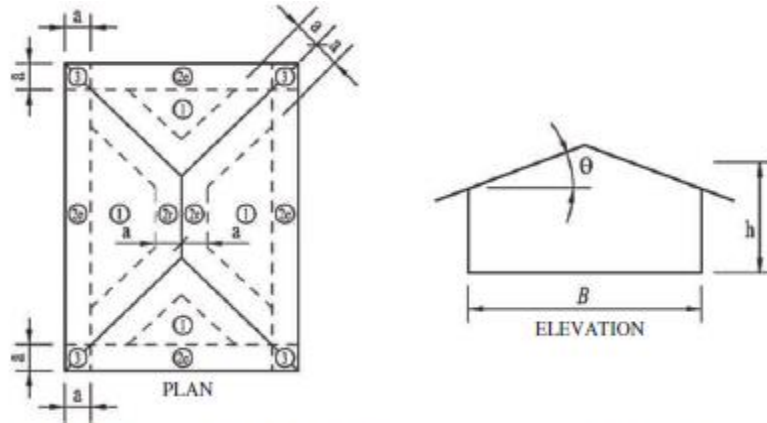

FIGURE 30.3-2G Components and Cladding [$h \leq 60$ ft ($h \leq 18.3$ m)]: External Pressure Coefficients, (GC_p), for Enclosed and Partially Enclosed Buildings—Hip Roofs, $20^\circ < \theta \leq 27^\circ$ (Roof and Overhang)

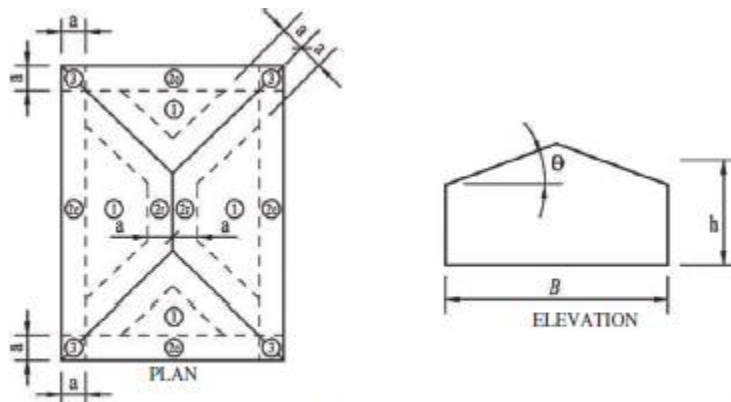
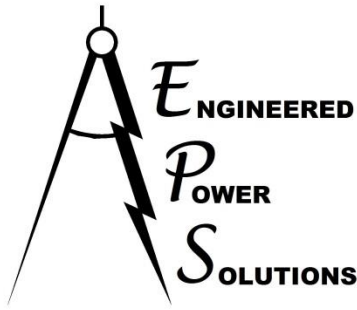

FIGURE 30.3-2H Components and Cladding [$h \leq 60$ ft ($h \leq 18.3$ m)]: External Pressure Coefficients, (GC_p), for Enclosed and Partially Enclosed Buildings—Hip Roofs, $27^\circ < \theta \leq 45^\circ$ (Roof)



ENGINEERED POWER SOLUTIONS

72 SOUTH MAIN STREET, SUITE A
TEMPLETON, CA 93465

Overhang conditions and overhang wind zones are not supported by this package.

The terms “a” and “h” are determined in accordance with the notes in Figures 30.3-2A-I.

- a: 10 percent of least horizontal dimension or $0.4h$, whichever is smaller, but not less than either 4% of least horizontal dimension or 3 ft.
- h: Mean roof height (ft.) except eave height shall be used for roof tilts $\leq 10^\circ$

See complete list of Notes of Figures 30.3-2A-I for additional clarification.

Note: It is the solar designer/installer or owner’s responsibility to determine the site-specific design parameters of each site based on the current governing building code and/or local jurisdiction’s requirements. It is also their responsibility to evaluate the PV layout specific conditions such as roof zone, edge zone factors, anchor capacity, etc. EPS is not responsible for incorrect use of the summary tables or using incorrect design parameters.

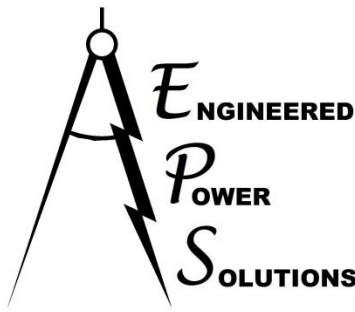

3.0 – SWH Rail Calculations

The SWH rail system consists of PV modules supported by two rails that span between anchorage points to anchorage hardware that anchor to the existing framing.

The previous sections addressed the various design loads and parameters provided by SWH that have been addressed in this packet. The results for all scenarios were provided in the previous tables. The following pages provide descriptions of the design methodology used as well as an example calculation using a specific set of parameters.

For the example calculations, a set of parameters have been chosen which may or may not represent an actual in-field scenario but will illustrate the design processed used for all provided parameters/scenarios.

- Example Scenario Design Parameters:
 - *Local Code:* *IBC referencing ASCE 7-16*
 - *Module Type:* *72 Cell*
 - *Rail Type:* *Standard Rail*
 - *Wind Exposure Category:* *C*
 - *Building Ht.:* *30 ft. (grade to highest point of PV installation)*
 - *Design Wind Speed:* *120 MPH*
 - *Design Ground Snow Load:* *30 psf*
 - *Roof Zone:* *Both Interior Zone and Edge Zone*
 - *Module Orientation:* *Portrait*
 - *Roof Pitch:* *10° (Gable or Hip Roof)*

Note: It is the solar designer/installer or owner's responsibility to determine the site specific design parameters of each site based on the current governing building code and/or local jurisdiction's requirements. It is also their responsibility to evaluate the PV layout specific conditions such as roof zone, edge zone factors, anchor capacity, etc. EPS is not responsible for incorrect use of the summary tables or using incorrect design parameters.

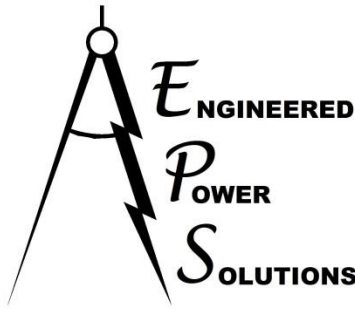

3.1 – Roof Zone Determination

Wind forces are determined in accordance with ASCE 7-16 Section 29.4.4. In accordance with Figures 30.3-2A-I, the roof has been broken up into (3) main zones, 1, 2, & 3 which also encompass all sub-zones (i.e., Zone 2 includes 2e, 2n, and 2r while Zone 3 includes 3, 3e, and 3r). See Figures in Section 2.4.

3.2 – Dead Loads

The dead load supported by each rail consists of the weight of the modules used over the tributary area of the rail. Since each rail supports the tributary width of half a module this would equate to the following weight for portrait condition:

Example Scenario Calculation:
72 Cell (55 lbs) = 2.54 psf.

*Portrait configuration trib. width: 3.25 ft. * 2.54 psf. = 8.3 plf*

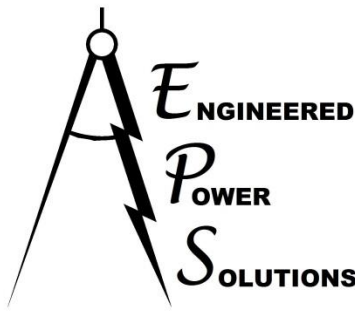

3.3 – Wind Forces

Per Section 29.4.4, the wind velocity pressure is determined by Equation Eq. 29.4-7:

$$p = q_h(GC_p)(\gamma_E)(\gamma_a) \text{ (psf)}$$

Where q_h , the velocity pressure evaluated at height h , is given by Section 26.10 and Equation 26.10-1:

- $q_h = 0.00256K_zK_{zt}K_dK_eV^2$ (ASCE 7-16)
 - K_z = Velocity Pressure Exposure Coefficient per Table 26.10-1
 - Exposure B: 0.70 ($h \leq 30\text{ft.}$)
 - Exposure C 0.98 ($h \leq 30\text{ft.}$)
 - K_{zt} = Topographic Factor per Section 26.8.2
 - This packet assumes no topographic factor ($K_{zt} = 1.00$)
 - K_d = Wind Directionality Factor per Section 26.6
 - 0.85
 - K_e = Ground Elevation Factor per Section 26.9
 - This packet conservatively uses 1.00 per note 1 of Table 26.9-1
 - $V = 3$ Second Gust Wind Speed per Section 26.5
- GC_p is the external pressure coefficient given in Figures 30.3-2A-I.
 - The GC_{pf} Coefficients are broken up by roof tilt and building surface location (zones). Each zone has an associated worst-case uplift coefficient as well as a worst-case downward coefficient (discussed in more detail later in this packet). The coefficient varies based on the effective wind area of the element being considered for design. The rail span summary tables in this packet assumed an effective wind area for the rails based on the continuous rails supporting a minimum of (5) modules. As noted in the tables, the listed spans shall be reduced by 1 ft. for continuous rails supporting less than (5) modules.
- γ_E – Array Edge Factor as defined in Fig. 29.4-7. This packet conservatively uses 1.5 for the array edge factor for all conditions.
- γ_a – Solar Panel Pressure Equalization Factor per Figure 29.4-8.
 - Like the GC_p factor, γ_a has been calculated based on the effective wind area of the rail.

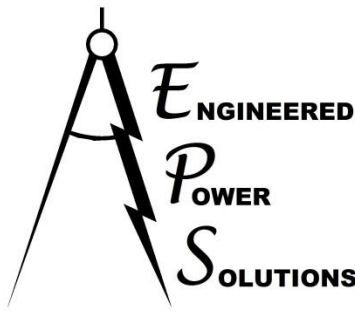

Example Scenario Calculation:

$$q_h = 0.00256(0.98)(1.0)(0.85)(1.0)(120)^2 = \mathbf{30.71 \text{ psf}}$$

External Pressure Coefficients (GC_p) for Example Scenario:

- Interior Zone of Roof (1) → Zone 1: -1.2
- Edge Zone of Roof (2) → Zone 2: -2.0
- Corner Zone of Roof (3) → Zone 3: -2.4
- Downward Load → All Zones: 0.4

$$\text{Interior Zone: } 30.71 \text{ psf} * -1.2 = -36.85 \text{ psf} * 3.25 \text{ ft.} = -119.8 \text{ plf}$$

$$\text{Edge Zone: } 30.71 \text{ psf} * -2.0 = -61.42 \text{ psf} * 3.25 \text{ ft.} = -199.6 \text{ plf}$$

$$\text{Corner Zone: } 30.71 \text{ psf} * -2.4 = -73.70 \text{ psf} * 3.25 \text{ ft.} = -239.5 \text{ plf}$$

$$\text{Downward Force: } 30.71 \text{ psf} * 0.4 = -12.28 \text{ psf} * 3.25 \text{ ft.} = 39.9 \text{ plf}$$

Based on the area of 72 cell (Tributary width = 3.25 ft.) the maximum uplift forces imposed on the modules have been calculated.

Using the worst-case wind uplift basic load combination (allowable stress design) of 0.6D+0.6W and the worst-case wind downward combination of 1.0D+0.6W as dictated in Section 2.4.1 provides the governing wind design load per rail.

Example Scenario Uplift Calculation:

- Interior Zone: $0.6*(8.3 \text{ plf}) - 0.6*(119.8 \text{ plf}) = \mathbf{-66.9 \text{ plf}}$
- Edge Zone: $0.6*(8.3 \text{ plf}) - 0.6*(199.6 \text{ plf}) = \mathbf{-114.8 \text{ plf}}$
- Corner Zone: $0.6*(8.3 \text{ plf}) - 0.6*(239.5 \text{ plf}) = \mathbf{-138.0 \text{ plf}}$
- Downward Force: $1.0*(8.3 \text{ plf}) + 0.6*(39.9 \text{ plf}) = \mathbf{32.2 \text{ plf}}$

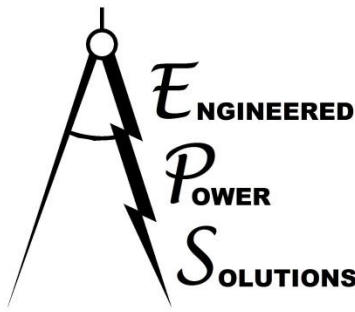

3.4 – Ground Snow Load Capacity

It is the responsibility of others to confirm that the existing building was designed correctly for the site specific design snow loads per the governing building code. The addition of a new rooftop PV system (mounted flush with the roof) does not change the amount of snow that falls on the roof but it can change how the snow load is distributed to the roof as the modules transfer the snow loads as numerous point loads through the anchorage points rather than an area load over the roof. The adequacy of the existing structure to support the PV loads (including changes to how the snow load is distributed) shall be checked by a registered licensed engineer as it is not the responsibility of EPS.

The design Roof Live Load is interchangeable with the design Roof Snow Load as noted in the load combinations. The point loads (uplift and downward) transferred by the PV racking system to the building's structural support system shall be evaluated by a registered licensed engineer during the building evaluation (not per EPS). Downward loads shall be calculated on a site by site basis by the engineering responsibility for justifying the building adequacy. If the calculated downward loads at the maximum allowable span is determined to be in excess of the allowable capacity of the building, shorter rail spans between anchors may be required to more evenly distribute the downward loads to the existing building (per building engineer).

The sloped roof snow load (p_s) is determined as follows:

- $p_s = p_f * C_s$ Eq. 7.4-1
- Flat Roof Snow Load $p_f = 0.7 * C_e * C_t * I * p_g$ Eq. 7.3-1
 - Exposure Factor C_e : 1.0 Table 7-2
 - Thermal Factor C_t : 1.2 Table 7-3
 - Snow Importance Factor (I): Table 1.5-2
 - 1.00 used in all cases
- $C_s = 1.00$ for tilts of 0° to 27° or 0.78 for tilts of 27° to 45°

Example Scenario Calculation:

$$\text{Sloped Roof Snow} = 1.00 * p_f$$

$$\text{Where } p_f = 0.7 * 1.0 * 1.2 * 1.00 * 30 \text{ psf} = 25.2 \text{ psf}$$

$$\text{Snow Load per Rail} = 25.2 \text{ psf.} * 3.25 \text{ ft.} = \mathbf{81.9 \text{ plf}}$$

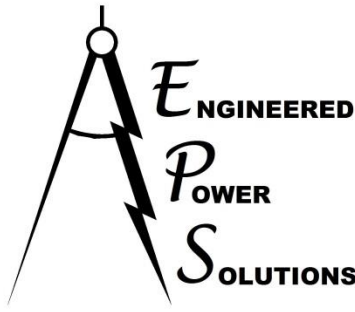

3.5 – Rail Load Summary

The governing compression (downward) loads at the anchors are from one of multiple load combinations. The governing load combination is dependant on the specific design parameters but the governing copression load combination will be from one of the following load combinations per Section 2.4.1:

- ASCE 7-16:
 - D
 - D+S
 - D+0.6W
 - D+0.75S+0.75(0.6W)

Example Scenario Calculation:

- Compressive loads:

D: 8.3 plf

S: 81.9 plf

W: 32.2 plf

D+S:

$$= 8.3 \text{ plf.} + 81.9 \text{ plf} = 90.2 \text{ plf}$$

D+0.6W

$$= 8.3 \text{ plf.} + 0.6(32.2 \text{ plf}) = 27.6 \text{ plf}$$

D+0.75S+0.75(0.6W)

$$= 8.3 \text{ plf.} + 0.75(81.9 \text{ plf}) + 0.75*(0.6*32.2 \text{ plf}) = 84.2 \text{ plf}$$

→ Therefore use **90.2 plf** compression load for typical rail.

The following pages provide the rail analysis results for the example case (loads for Wind Zone 1 shown). The Rail spans are shown on the first sheet and are in ½ foot increments.

[A similar rail analysis has been calculated for each separate case detailed in the tables (not shown in this packet)]

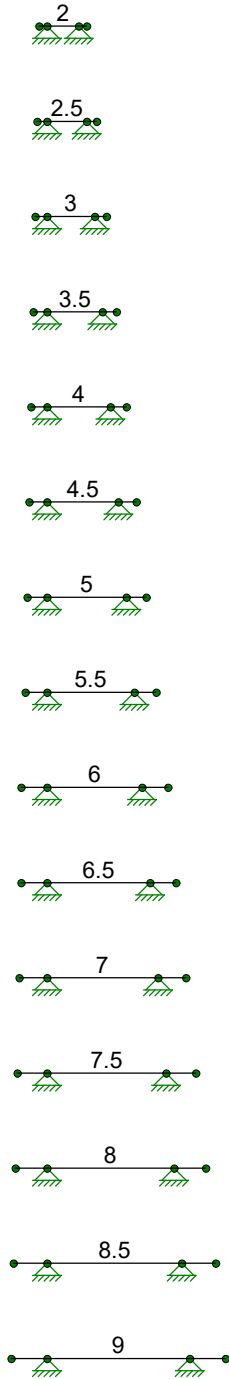

Envelope Only Solution

EPS	SWH Rail Analysis	SK - 2
MBG		Jan 15, 2020 at 9:40 AM
20-SWH001		Example Rail Check.r3d

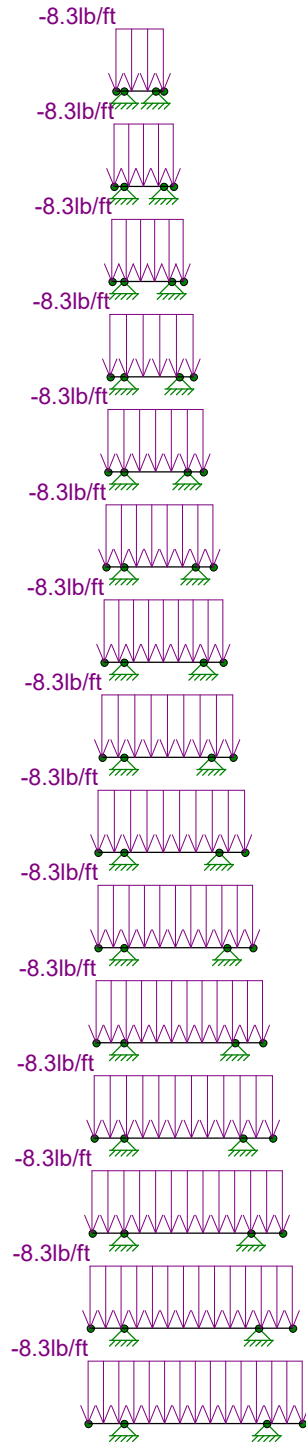

Loads: BLC 1, Dead
Envelope Only Solution

EPS

MBG

20-SWH001

SWH Rail Analysis

SK - 3

Jan 15, 2020 at 9:40 AM

Example Rail Check.r3d

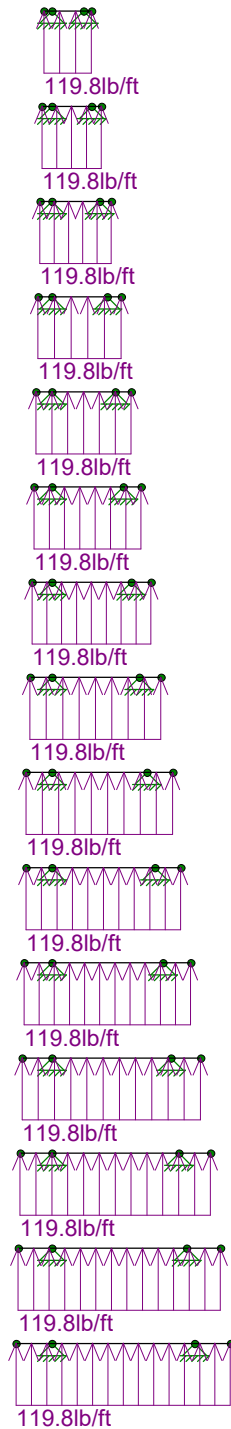

Loads: BLC 2, Wind Up
Envelope Only Solution

EPS

MBG

20-SWH001

SWH Rail Analysis

SK - 4

Jan 15, 2020 at 9:41 AM

Example Rail Check.r3d

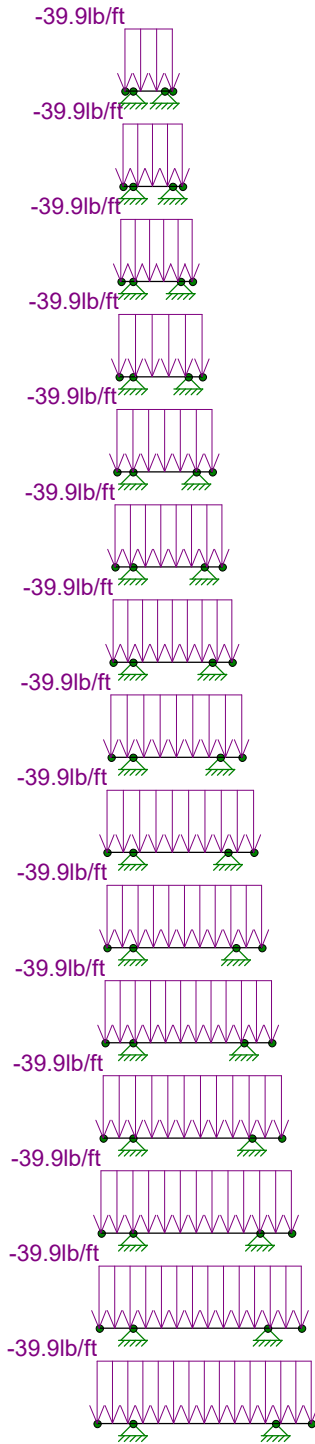

Loads: BLC 3, Wind Down
Envelope Only Solution

EPS	SWH Rail Analysis	SK - 5
MBG		Jan 15, 2020 at 9:41 AM
20-SWH001		Example Rail Check.r3d

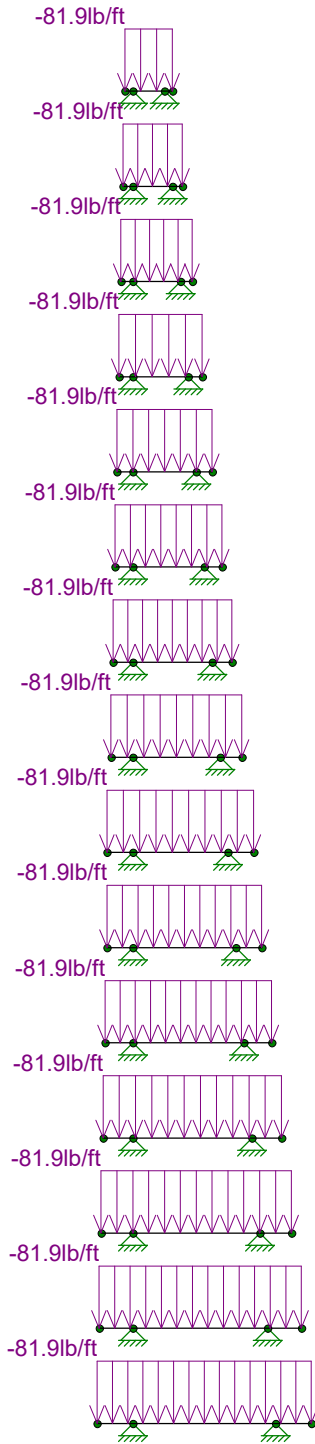

Loads: BLC 4, Snow
Envelope Only Solution

EPS
MBG
20-SWH001

SWH Rail Analysis

SK - 6
Jan 15, 2020 at 9:41 AM
Example Rail Check.r3d

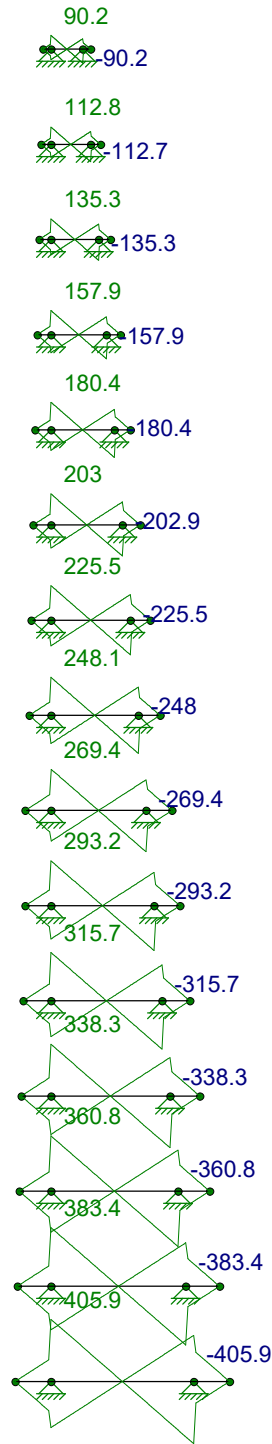

Envelope Only Solution
Member y Shear Forces (lb) (Enveloped)

EPS	SWH Rail Analysis	SK - 7
MBG		Jan 15, 2020 at 9:41 AM
20-SWH001		Example Rail Check.r3d

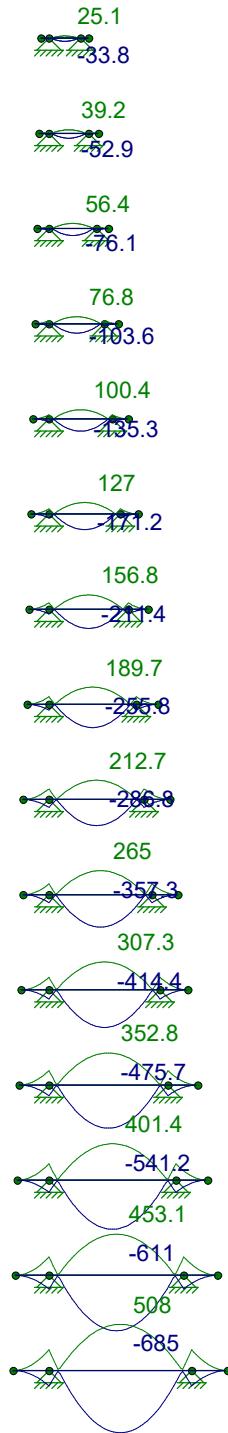

Envelope Only Solution
Member z Bending Moments (lb-ft) (Enveloped)

EPS	SWH Rail Analysis	SK - 8
MBG		Jan 15, 2020 at 9:41 AM
20-SWH001		Example Rail Check.r3d



Basic Load Cases

	BLC Description	Category	X Gravity	Y Gravity	Z Gravity	Joint	Point	Distributed	Area(M...Surface...
1	Dead	DL						15	
2	Wind Up	WL						15	
3	Wind Down	WL						15	
4	Snow	SL						15	

Load Combinations

	Description	So...PDe...SR...	BLCFac...	BLC	Fac..BLCFac..BLCFac..BLCFac..BLCFac..BLCFac..BLCFac..BLCFac..BLCFac..BLCFac..
1	ASCE ASD 1	Yes Y	DL 1		
2	ASCE ASD 2	Yes Y	DL 1	LL 1	LLS 1
3	ASCE ASD 3...	Yes Y	DL 1		
4	ASCE ASD 3...	Yes Y	DL 1	SL 1	SLN 1
5	ASCE ASD 4...	Yes Y	DL 1	LL .75	LLS .75 SL .75 SLN .75
6	ASCE ASD 5...	Yes Y	DL 1	2 .6	
7	ASCE ASD 5...	Yes Y	DL 1	3 .6	
8	ASCE ASD 6...	Yes Y	DL 1	2 .45 LL .75	LLS .75
9	ASCE ASD 6...	Yes Y	DL 1	3 .45 LL .75	LLS .75
10	ASCE ASD 6...	Yes Y	DL 1	2 .45 LL .75	LLS .75 SL .75 SLN .75
11	ASCE ASD 6...	Yes Y	DL 1	3 .45 LL .75	LLS .75 SL .75 SLN .75
12	ASCE ASD 7	Yes Y	DL .6	2 .6	
13	ASCE ASD 7	Yes Y	DL .6	3 .6	

Envelope Member Section Forces

Member	Sec	Axial[lb]	LC	y Shear[lb]	LC	z Shear[lb]	LC	Torque[lb-ft]	LC	y-y Momen...	LC	z-z Momen...	LC	
1	2	1 max	0	1	0	1	0	1	0	1	0	1	0	1
2		min	0	1	0	1	0	1	0	1	0	1	0	1
3		2 max	0	1	67.65	4	0	1	0	1	0	1	6.272	12
4		min	0	1	-50.175	12	0	1	0	1	0	1	-8.456	4
5		3 max	0	1	0	1	0	1	0	1	0	1	25.087	12
6		min	0	1	0	1	0	1	0	1	0	1	-33.825	4
7		4 max	0	1	50.175	12	0	1	0	1	0	1	6.272	12
8		min	0	1	-67.65	4	0	1	0	1	0	1	-8.456	4
9		5 max	0	1	0	1	0	1	0	1	0	1	0	1
10		min	0	1	0	1	0	1	0	1	0	1	0	1
11	2.5	1 max	0	1	0	1	0	1	0	1	0	1	0	1
12		min	0	1	0	1	0	1	0	1	0	1	0	1
13		2 max	0	1	84.563	4	0	1	0	1	0	1	9.8	12
14		min	0	1	-62.719	12	0	1	0	1	0	1	-13.213	4
15		3 max	0	1	0	1	0	1	0	1	0	1	39.199	12
16		min	0	1	0	1	0	1	0	1	0	1	-52.852	4
17		4 max	0	1	62.719	12	0	1	0	1	0	1	9.8	12
18		min	0	1	-84.563	4	0	1	0	1	0	1	-13.213	4
19		5 max	0	1	0	1	0	1	0	1	0	1	0	1
20		min	0	1	0	1	0	1	0	1	0	1	0	1
21	3	1 max	0	1	0	1	0	1	0	1	0	1	0	1
22		min	0	1	0	1	0	1	0	1	0	1	0	1
23		2 max	0	1	101.475	4	0	1	0	1	0	1	14.112	12
24		min	0	1	-75.262	12	0	1	0	1	0	1	-19.027	4
25		3 max	0	1	0	1	0	1	0	1	0	1	56.447	12
26		min	0	1	0	1	0	1	0	1	0	1	-76.106	4
27		4 max	0	1	75.263	12	0	1	0	1	0	1	14.112	12
28		min	0	1	-101.475	4	0	1	0	1	0	1	-19.027	4
29		5 max	0	1	0	1	0	1	0	1	0	1	0	1
30		min	0	1	0	1	0	1	0	1	0	1	0	1



Company : EPS
 Designer : MBG
 Job Number : 20-SWH001
 Model Name : SWH Rail Analysis

Jan 15, 2020
 9:42 AM
 Checked By: _____

Envelope Member Section Forces (Continued)

Member	Sec		Axial[lb]	LC	y Shear[lb]	LC	z Shear[lb]	LC	Torque[lb-ft]	LC	y-y Momen...	LC	z-z Momen...	LC	
31	3.5	1	max	0	1	0	1	0	1	0	1	0	1	0	1
32			min	0	1	0	1	0	1	0	1	0	1	0	1
33		2	max	0	1	118.388	4	0	1	0	1	0	1	19.208	12
34			min	0	1	-87.806	12	0	1	0	1	0	1	-25.897	4
35		3	max	0	1	0	1	0	1	0	1	0	1	76.83	12
36			min	0	1	0	1	0	1	0	1	0	1	-103.589	4
37		4	max	0	1	87.806	12	0	1	0	1	0	1	19.208	12
38			min	0	1	-118.388	4	0	1	0	1	0	1	-25.897	4
39		5	max	0	1	0	1	0	1	0	1	0	1	0	1
40			min	0	1	0	1	0	1	0	1	0	1	0	1
41	4	1	max	0	1	0	1	0	1	0	1	0	1	0	1
42			min	0	1	0	1	0	1	0	1	0	1	0	1
43		2	max	0	1	135.3	4	0	1	0	1	0	1	25.088	12
44			min	0	1	-100.35	12	0	1	0	1	0	1	-33.825	4
45		3	max	0	1	0	1	0	1	0	1	0	1	100.35	12
46			min	0	1	0	1	0	1	0	1	0	1	-135.3	4
47		4	max	0	1	100.35	12	0	1	0	1	0	1	25.088	12
48			min	0	1	-135.3	4	0	1	0	1	0	1	-33.825	4
49		5	max	0	1	0	1	0	1	0	1	0	1	0	1
50			min	0	1	0	1	0	1	0	1	0	1	0	1
51	4.5	1	max	0	1	0	1	0	1	0	1	0	1	0	1
52			min	0	1	0	1	0	1	0	1	0	1	0	1
53		2	max	0	1	152.213	4	0	1	0	1	0	1	31.751	12
54			min	0	1	-112.894	12	0	1	0	1	0	1	-42.81	4
55		3	max	0	1	0	1	0	1	0	1	0	1	127.005	12
56			min	0	1	0	1	0	1	0	1	0	1	-171.239	4
57		4	max	0	1	112.894	12	0	1	0	1	0	1	31.751	12
58			min	0	1	-152.212	4	0	1	0	1	0	1	-42.81	4
59		5	max	0	1	0	1	0	1	0	1	0	1	0	1
60			min	0	1	0	1	0	1	0	1	0	1	0	1
61	5	1	max	0	1	0	1	0	1	0	1	0	1	0	1
62			min	0	1	0	1	0	1	0	1	0	1	0	1
63		2	max	0	1	169.125	4	0	1	0	1	0	1	39.199	12
64			min	0	1	-125.438	12	0	1	0	1	0	1	-52.852	4
65		3	max	0	1	0	1	0	1	0	1	0	1	156.797	12
66			min	0	1	0	1	0	1	0	1	0	1	-211.406	4
67		4	max	0	1	125.437	12	0	1	0	1	0	1	39.199	12
68			min	0	1	-169.125	4	0	1	0	1	0	1	-52.852	4
69		5	max	0	1	0	1	0	1	0	1	0	1	0	1
70			min	0	1	0	1	0	1	0	1	0	1	0	1
71	5.5	1	max	0	1	0	1	0	1	0	1	0	1	0	1
72			min	0	1	0	1	0	1	0	1	0	1	0	1
73		2	max	0	1	186.038	4	0	1	0	1	0	1	47.431	12
74			min	0	1	-137.981	12	0	1	0	1	0	1	-63.95	4
75		3	max	0	1	0	1	0	1	0	1	0	1	189.724	12
76			min	0	1	0	1	0	1	0	1	0	1	-255.802	4
77		4	max	0	1	137.981	12	0	1	0	1	0	1	47.431	12
78			min	0	1	-186.037	4	0	1	0	1	0	1	-63.95	4
79		5	max	0	1	0	1	0	1	0	1	0	1	0	1
80			min	0	1	0	1	0	1	0	1	0	1	0	1
81	6	1	max	0	1	0	1	0	1	0	1	0	1	0	1
82			min	0	1	0	1	0	1	0	1	0	1	0	1
83		2	max	0	1	208.588	4	0	1	0	1	0	1	33.842	12
84			min	0	1	-154.706	12	0	1	0	1	0	1	-45.629	4
85		3	max	0	1	0	1	0	1	0	1	0	1	212.721	12
86			min	0	1	0	1	0	1	0	1	0	1	-286.808	4
87		4	max	0	1	154.706	12	0	1	0	1	0	1	33.842	12



Company : EPS
 Designer : MBG
 Job Number : 20-SWH001
 Model Name : SWH Rail Analysis

Jan 15, 2020
 9:42 AM
 Checked By: _____

Envelope Member Section Forces (Continued)

Member	Sec		Axial[lb]	LC	v Shear[lb]	LC	z Shear[lb]	LC	Torque[lb-ft]	LC	v-y Momen...	LC	z-z Momen...	LC
88		min	0	1	-208.587	4	0	1	0	1	0	1	-45.629	4
89	5	max	0	1	0	1	0	1	0	1	0	1	0	1
90		min	0	1	0	1	0	1	0	1	0	1	0	1
91	6.5	1 max	0	1	0	1	0	1	0	1	0	1	0	1
92		min	0	1	0	1	0	1	0	1	0	1	0	1
93	2	max	0	1	219.863	4	0	1	0	1	0	1	66.247	12
94		min	0	1	-163.069	12	0	1	0	1	0	1	-89.319	4
95	3	max	0	1	0	1	0	1	0	1	0	1	264.987	12
96		min	0	1	0	1	0	1	0	1	0	1	-357.277	4
97	4	max	0	1	163.069	12	0	1	0	1	0	1	66.247	12
98		min	0	1	-219.863	4	0	1	0	1	0	1	-89.319	4
99	5	max	0	1	0	1	0	1	0	1	0	1	0	1
100		min	0	1	0	1	0	1	0	1	0	1	0	1
101	7	1 max	0	1	0	1	0	1	0	1	0	1	0	1
102		min	0	1	0	1	0	1	0	1	0	1	0	1
103	2	max	0	1	236.775	4	0	1	0	1	0	1	76.83	12
104		min	0	1	-175.612	12	0	1	0	1	0	1	-103.589	4
105	3	max	0	1	0	1	0	1	0	1	0	1	307.322	12
106		min	0	1	0	1	0	1	0	1	0	1	-414.356	4
107	4	max	0	1	175.613	12	0	1	0	1	0	1	76.83	12
108		min	0	1	-236.775	4	0	1	0	1	0	1	-103.589	4
109	5	max	0	1	0	1	0	1	0	1	0	1	0	1
110		min	0	1	0	1	0	1	0	1	0	1	0	1
111	7.5	1 max	0	1	0	1	0	1	0	1	0	1	0	1
112		min	0	1	0	1	0	1	0	1	0	1	0	1
113	2	max	0	1	253.688	4	0	1	0	1	0	1	88.198	12
114		min	0	1	-188.156	12	0	1	0	1	0	1	-118.916	4
115	3	max	0	1	0	1	0	1	0	1	0	1	352.793	12
116		min	0	1	0	1	0	1	0	1	0	1	-475.664	4
117	4	max	0	1	188.156	12	0	1	0	1	0	1	88.198	12
118		min	0	1	-253.687	4	0	1	0	1	0	1	-118.916	4
119	5	max	0	1	0	1	0	1	0	1	0	1	0	1
120		min	0	1	0	1	0	1	0	1	0	1	0	1
121	8	1 max	0	1	0	1	0	1	0	1	0	1	0	1
122		min	0	1	0	1	0	1	0	1	0	1	0	1
123	2	max	0	1	270.6	4	0	1	0	1	0	1	100.35	12
124		min	0	1	-200.7	12	0	1	0	1	0	1	-135.3	4
125	3	max	0	1	0	1	0	1	0	1	0	1	401.4	12
126		min	0	1	0	1	0	1	0	1	0	1	-541.2	4
127	4	max	0	1	200.7	12	0	1	0	1	0	1	100.35	12
128		min	0	1	-270.6	4	0	1	0	1	0	1	-135.3	4
129	5	max	0	1	0	1	0	1	0	1	0	1	0	1
130		min	0	1	0	1	0	1	0	1	0	1	0	1
131	8.5	1 max	0	1	0	1	0	1	0	1	0	1	0	1
132		min	0	1	0	1	0	1	0	1	0	1	0	1
133	2	max	0	1	287.512	4	0	1	0	1	0	1	113.286	12
134		min	0	1	-213.244	12	0	1	0	1	0	1	-152.741	4
135	3	max	0	1	0	1	0	1	0	1	0	1	453.143	12
136		min	0	1	0	1	0	1	0	1	0	1	-610.964	4
137	4	max	0	1	213.244	12	0	1	0	1	0	1	113.286	12
138		min	0	1	-287.512	4	0	1	0	1	0	1	-152.741	4
139	5	max	0	1	0	1	0	1	0	1	0	1	0	1
140		min	0	1	0	1	0	1	0	1	0	1	0	1
141	9	1 max	0	1	0	1	0	1	0	1	0	1	0	1
142		min	0	1	0	1	0	1	0	1	0	1	0	1
143	2	max	0	1	304.425	4	0	1	0	1	0	1	127.005	12
144		min	0	1	-225.787	12	0	1	0	1	0	1	-171.239	4



Company : EPS
 Designer : MBG
 Job Number : 20-SWH001
 Model Name : SWH Rail Analysis

Jan 15, 2020
 9:42 AM
 Checked By: _____

Envelope Member Section Forces (Continued)

Member	Sec		Axial[lb]	LC	y Shear[lb]	LC	z Shear[lb]	LC	Torque[lb-ft]	LC	y-y Momen...	LC	z-z Momen...	LC
145	3	max	0	1	0	1	0	1	0	1	0	1	508.022	12
146		min	0	1	0	1	0	1	0	1	0	1	-684.956	4
147	4	max	0	1	225.787	12	0	1	0	1	0	1	127.005	12
148		min	0	1	-304.425	4	0	1	0	1	0	1	-171.239	4
149	5	max	0	1	0	1	0	1	0	1	0	1	0	1
150		min	0	1	0	1	0	1	0	1	0	1	0	1

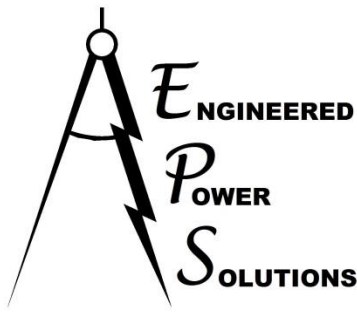

3.6 – Rail Analysis

Below are the section properties of the SWH rails (Standard and Ecolite).

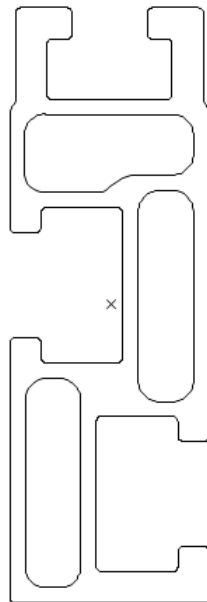

Plane Properties:
Area: 0.59279 sq in
Perimeter: 14.666 in

Centroid:
xC: 12.61 in
yC: -1.187 in

Section Properties:
About The Centroidal X-Axis:
Moment of Inertia: 0.29782 in⁴
Section Modulus: 0.26453 in³
Radius of Gyration: 0.70881 in

About The Centroidal Y-Axis:
Moment of Inertia: 0.03799 in⁴
Section Modulus: 0.09935 in³
Radius of Gyration: 0.25314 in

Figure 2a: Standard Rail

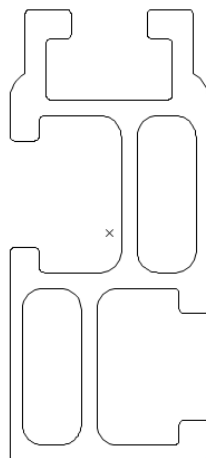

Plane Properties:
Area: 0.39583 sq in
Perimeter: 10.893 in

Centroid:
xC: 12.75 in
yC: -6.337 in

Section Properties:
About The Centroidal X-Axis:
Moment of Inertia: 0.11190 in⁴
Section Modulus: 0.13119 in³
Radius of Gyration: 0.53170 in

About The Centroidal Y-Axis:
Moment of Inertia: 0.02375 in⁴
Section Modulus: 0.06354 in³
Radius of Gyration: 0.24493 in

Figure 2b: Ecolite Rail

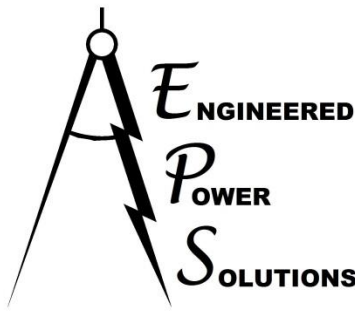

ENGINEERED POWER SOLUTIONS

72 SOUTH MAIN STREET, SUITE A
 TEMPLETON, CA 93465

Per the Aluminum Design Manual, the allowable stress for the proposed 6005-T5 aluminum rails (38,000 psi min. ultimate tensile strength) is 19.5 ksi.

Based on this allowable stress and the section modulus of each rail listed on the previous page, the maximum allowable moment for the Standard Rail is 429 lb-ft and the maximum allowable moment for the Ecolite Rail is 213 lb-ft.

Each loading condition listed in the summary table was analyzed to determine the maximum moments of all spans in a similar manner as shown in the example scenario. The maximum moments were compared to the allowable load limits listed above to determine the maximum allowable spans.

Example Scenario:

The rail is governed by downward compression loads from dead plus snow loads with a maximum moment of 414 lb-ft. with a 7 ft. span. The 7.5 ft. span condition has a maximum moment of 476 lb-ft. which exceeds the Standard Rail maximum allowable moment of 429 lb-ft. and therefore, the maximum span under the example conditions listed is 7 ft. This matches the span noted in the summary tables for this condition.

Standard Rail - Risk Cat. II

Portrait

Slope 7° - 20°

Zone 1	Wind Speed (mph)	Ground Snow Load (psf)										
		0	10	20	30	40	50	60	70	80	90	100
Exp C	100	9.0	9.0	8.5	7.0	6.0	5.5	5.0	4.5	4.5	4.0	4.0
	110	8.5	8.5	8.0	7.0	6.0	5.5	5.0	4.5	4.5	4.0	4.0
	115	8.0	8.0	8.0	7.0	6.0	5.5	5.0	4.5	4.5	4.0	4.0
	120	7.5	7.5	7.5	7.0	6.0	5.5	5.0	4.5	4.5	4.0	4.0
	130	7.0	7.0	7.0	6.5	6.0	5.5	5.0	4.5	4.5	4.0	4.0
	140	6.5	6.5	6.5	6.5	5.5	5.5	5.0	4.5	4.5	4.0	4.0
	150	6.0	6.0	6.0	6.0	5.5	5.5	5.0	4.5	4.5	4.0	4.0
	160	5.5	5.5	5.5	5.5	5.5	5.0	5.0	4.5	4.5	4.0	4.0
	170	5.0	5.0	5.0	5.0	5.0	5.0	5.0	4.5	4.5	4.0	4.0
	180	4.5	4.5	4.5	4.5	4.5	4.5	4.5	4.5	4.5	4.0	4.0
	200	3.0	3.0	3.0	3.0	3.0	3.0	3.0	3.0	3.0	3.0	3.0

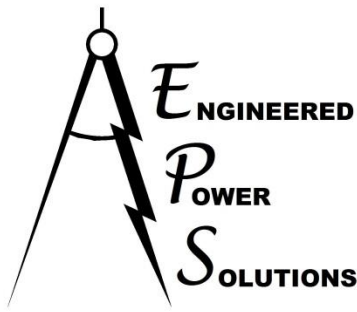

3.7 – Rail Splice

Below are the section properties of the Rail Splice.

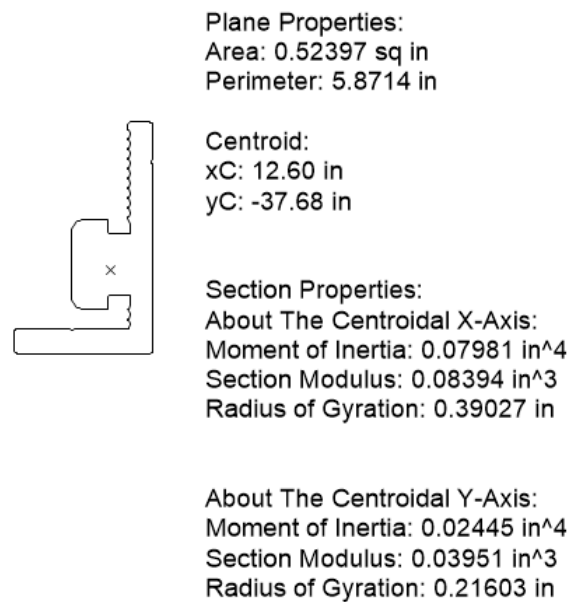

Figure 3: Rail Splice